

SK HLD-110-500/16

Part number: 278 272 016

Chassis line filter



Only qualified electricians are allowed to install and commission the module. An electrician is a person who, because of their technical training and experience, has sufficient knowledge with regard to

- switching on, switching off, isolating, earthing and marking power circuits and devices,
- proper maintenance and use of protective devices in accordance with defined safety standards.

DANGER!

Danger of electric shock

The frequency inverter continues to carry hazardous voltages for up to 5 minutes after it was switched off.

- Work must not be carried out unless the device has been disconnected from the voltage and at least 5 minutes have elapsed since the mains was switched off!

CAUTION

Danger of burns

The module and all other metal components can heat up to temperatures above 70 °C.

Sufficient cooling time must be allowed for when working on the components in order to avoid injuries (local burns) to parts of the body coming into contact with the components.

In order to avoid damage to neighbouring objects, sufficient clearance must be maintained during installation.

NOTICE

Validity of this document

This document is only valid in combination with the operating instructions for the relevant frequency inverter. Safe commissioning of this module and the frequency inverter depends on the availability of this information.

Technical Information / Datasheet	SK HLD 110-500/16			
Line filter	TI 278272016	V 1.1	1717	EN

Scope of supply

1 x	Module	SK HLD-110-500/16
-----	--------	-------------------



Field of use

Input filter (line filter) to reduce the emission of electromagnetic interference. In combination with this chassis line filter (interference suppression filter), the radio interference suppression level of the frequency inverter improves, and a longer motor cable is possible. The module can be mounted next to or in the immediate vicinity of the frequency inverter.

i Information

Suppression level

With a chassis line filter, cable-related emissions of limit value class C1 can be achieved up to a maximum motor cable length of 25 m.

Technical Data

Electrical data

Number of phases		3	Leakage current 1)	mA	205 / 21
Rated voltage	V ~	520	Test voltage 2)	V -	2150 / 3500
Rated frequency	Hz	50 ... 60	Resistance on line	mΩ	9.8
Rated current	A	16.0 (U _T ≈ 50 °C)	Power dissipation	W	12.0

- ¹⁾ 1st value: Calculated with max. input voltage and failure of 2 phases (typically at 50 Hz)
 2nd value: Rated for the maximum permissible input voltage fluctuation as per IEC 38 ± 10 %
- ²⁾ 1st value: between 2 phases
 2nd value: 2 s value: between phase and housing

General

Temperature range	°C	0 ... 40 (100 % duty cycle / S1) 0 ... 50 (70 % duty cycle / S3)	European standard	EN 60939-2
Climate class		25/085/21 (EN 60068-1)	Mounting 1)	
Certifications		EAC UL 1283 5. edition CSA C22.2 No. 8	Standard position	4 x M5 x 8 (mounting surface)
Tightening torque	Nm	0.8 Terminal 3.0 PE connection	Protection class	IP20
Weight	kg	1.2	¹⁾ not part of the delivery, use washers if applicable	

Dimensions

Envelope dimensions [mm]	L x W x H	250 x 45 x 75
Mounting [mm]		
Standard position	L x W	240 x 20

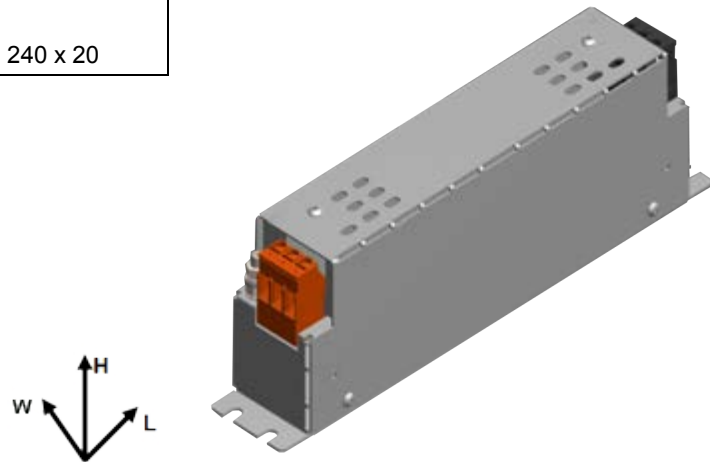

Connections

Name	PE connection at the top / bottom	Input top (L1, L2, L3)		Output at bottom (L12, L22, L32) ²⁾	
Type	2 bolts ¹⁾	Socket part, screw terminals, 3-pole		Socket part, screw terminals, 3-pole	
Cross section / type	M5	4 mm ²	AWG 12	4 mm ²	AWG 12

¹⁾ incl. 2 washers, 1 spring washer, 2 M5 nuts

²⁾ Name can differ for older versions.

Frequency inverter assignment

Information

Overview in the manual





The chassis line filters provided by Getriebebau NORD are directly tailored to the individual frequency inverters.

For more detailed information, please refer to chapter "Line filter SK HLD of the manual  "Further documentation and software: www.nord.com" for the respective frequency inverter.

Installation

Installation location	In a control cabinet: <ul style="list-style-type: none"> • sideways of the frequency inverter, or • in its immediate vicinity
Installation orientation	Standard (vertical) <ul style="list-style-type: none"> • Keep a minimum distance of 100 mm above and below other devices or control cabinet components
Fastening	With screws (fastening material has to be provided)

Installation steps

1.	<p>Installing the unit</p> <p><i>Standard position:</i> Install a unit with its underside flat on a level surface (control cabinet rear wall) and screw in with 4 screws to be provided (see  Technical Data – Fastening) into the respective fastening bores.</p>	 <p>Standard position</p>
2.	<p>Installing the frequency inverter</p> <p><i>Standard position:</i> Install a frequency inverter with its underside on a level surface (control cabinet rear wall) and fasten it with 2 or 4 screws to be provided (depending on the size) to the provided wall mounting brackets.</p>	
3.	<p>Connect the power cable and the PE connection to terminals PE, L1, L2, L3 of the input terminal block while heeding the specified tightening torques (see  Technical Data – Connections).</p> <p>Note: Establish the PE connection first!</p>	
4.	<p>The connecting material (cables are not part of the delivery) has to be connected from the output terminals (bottom) L12, L22, L32, PE2 to terminal strip X1 ¹⁾ of the frequency inverter (PE, L1, L2, L3) for mains connection.</p> <p>Please refer to the manuals for the tightening torques (see  "Further documentation and software: www.nord.com").</p> <p>If a line filter is to be used for several frequency inverters, connect the frequency inverters in parallel to the output terminals or loop them through.</p>	

¹⁾ X1 for sizes 1 - 7 X1.1 and X1.2 for size 8 and above

NOTICE

Connection and EMC configuration

For information on how to connect the line filter, on the jumper settings required for compliance with the limit value classes, please refer to the respective manual  "Further documentation and software: www.nord.com". For frequency inverters of sizes 1 – 7, jumpers A and B have to be used. For frequency inverters of sizes 8 – 11, DIP switch EMC Filter has to be used.

Non-compliance or incorrect jumper settings can destroy the frequency inverter.

Wiring diagram

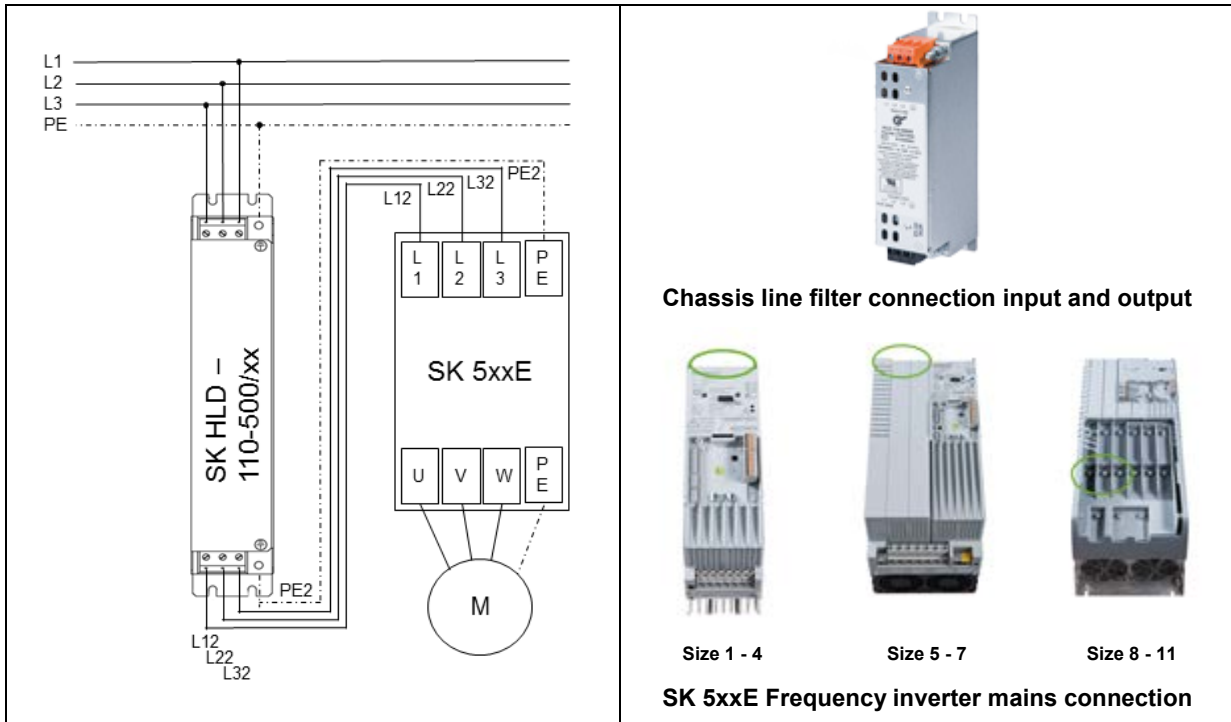

Further documentation and software: www.nord.com

Document	Name
BU 0500	SK 500E – SK 535E frequency inverter manual

Document	Name
BU 0505	SK 54xE frequency inverter manual