

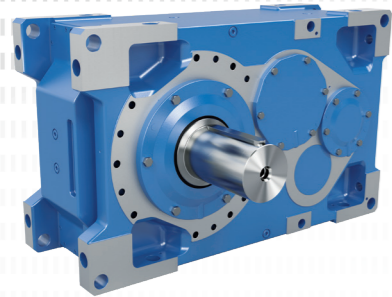

**Complete drive solutions
from a single source**
Geared motors and frequency inverters

NORD[®]
DRIVESYSTEMS
Our Solution. Your Success.



Industrial gear units

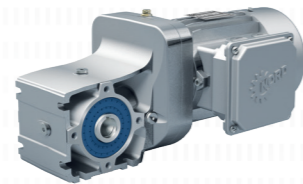

Geared motors

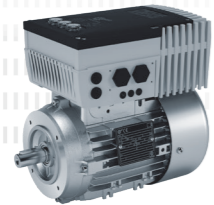

Frequency inverters and motor starters



- ▶ Headquarters and technology centre in Bargteheide near Hamburg.
- ▶ Innovative drive solutions for more than 100 branches of industry.
- ▶ 7 production locations with cutting edge technology produce gear units, motors and drive electronics for complete drive systems from a single source.
- ▶ NORD has 48 subsidiaries in 36 countries and further sales partners in more than 50 countries, providing local stocks, assembly centres, technical support and customer service.
- ▶ More than 4,900 employees throughout the world create customised solutions.



Headquarters in Bargteheide



Gear unit production



Inverter production



Motor production



Production and assembly



Motor mounting

Complete drive solutions from a single source

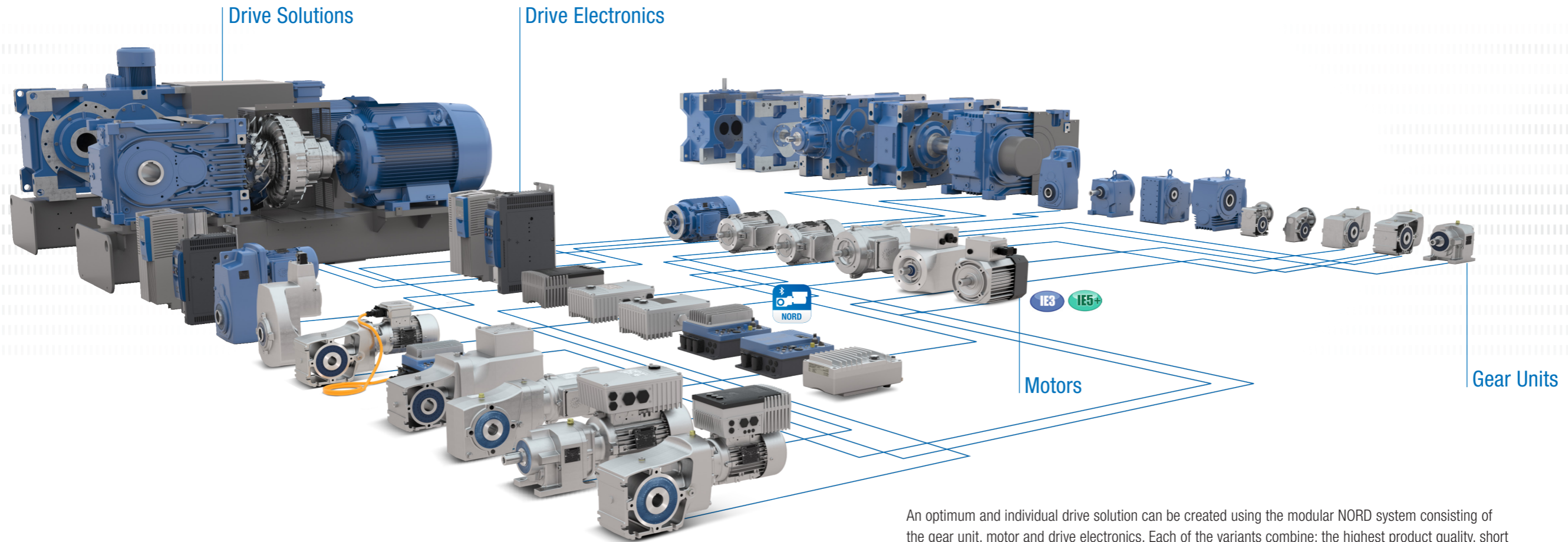

ATEX
Our products are available in ATEX-certified versions.

An optimum and individual drive solution can be created using the modular NORD system consisting of the gear unit, motor and drive electronics. Each of the variants combine: the highest product quality, short planning and assembly times, high delivery availability, and a good price/performance ratio.



Reliable gear units with one-piece UNICASE housing can cater for any load.

- ▶ High power density
- ▶ Long service life

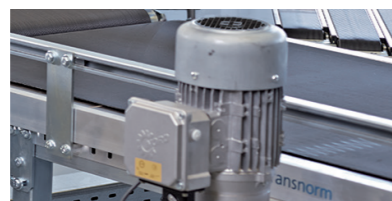

Powerful motors up to IE4 keep drive systems in motion in all operating situations.

- ▶ Designed in compliance with international standards
- ▶ High overload capacity
- ▶ Energy-efficient



Intelligent drive electronics provide exactly the control options which you need.

- ▶ Scalable functions
- ▶ Full field bus connection facilities
- ▶ Wide power range
- ▶ PLC integrated at no extra cost



Extensive communication options enable access to drives from all levels to enable a wide variety of setting options.

- ▶ All common bus systems
- ▶ Quick and simple commissioning with plug-in control box or using NORDCON software
- ▶ Convenient hand held console for local operation
- ▶ Optionally with intralogistics options



Switches and keys are located directly on the drives and enable direct starting and stopping as well as mode switching.

- ▶ Mains switch
- ▶ Selector switch for local or remote control
- ▶ Start/Stop and Forward/Reverse switch
- ▶ Energy-efficient



All interfaces are designed for ease of use. Drives can be easily configured and installed.

- ▶ Simple Plug-and-Play with all common connection plugs
- ▶ Plug-in supply cable and motor output
- ▶ Plug-in sensors and encoders
- ▶ Pre-assembled cables
- ▶ PLC integrated at no extra cost

Our Solution. Your Success.

Extensive expertise for your application.

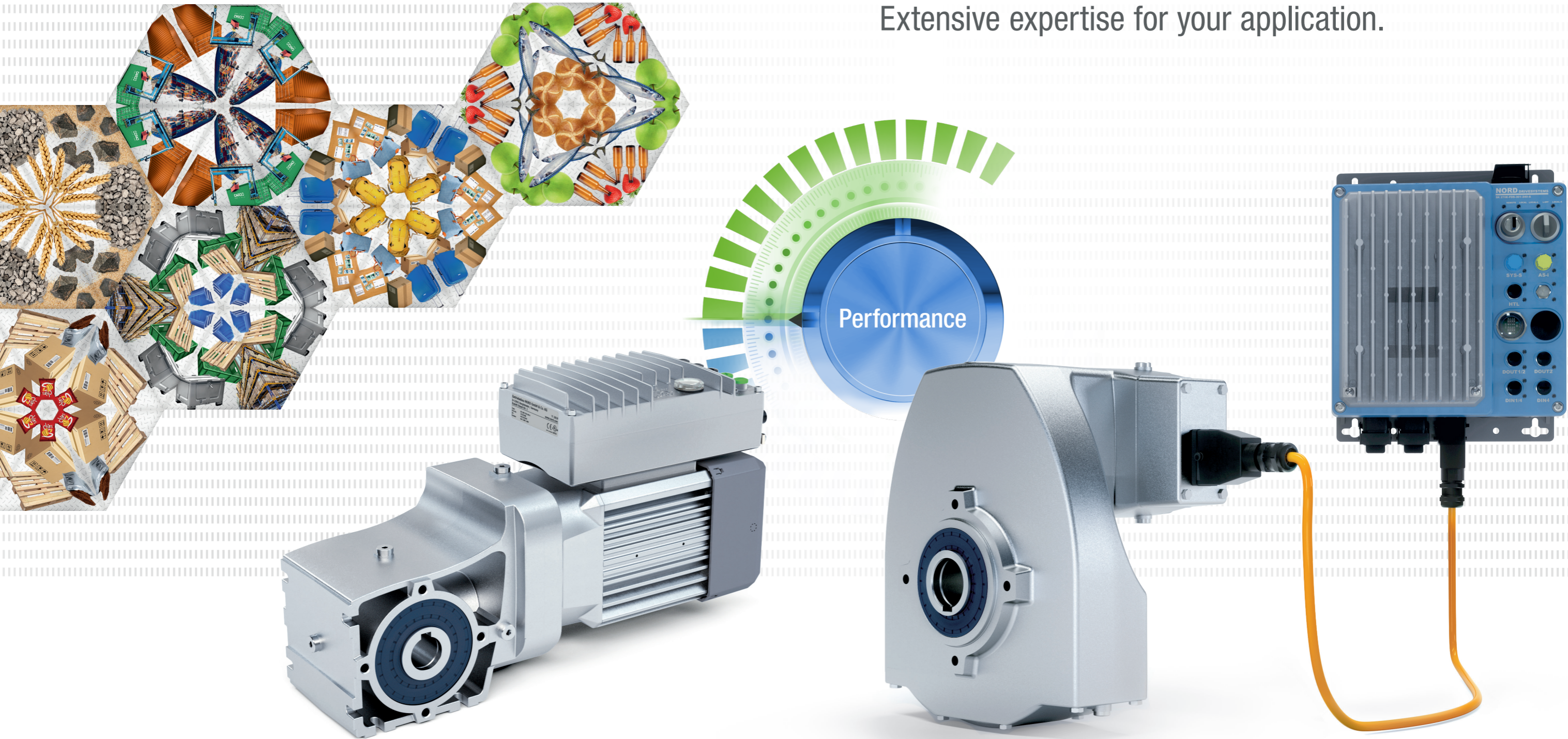

Complete drive solutions from a single source

As early as 1981 NORD DRIVESYSTEMS developed the revolutionary UNICASE housing. An enclosed gear unit housing which combines all elements of the gear unit is produced from a single piece of material.

- ▶ A housing block which integrates all bearing points
- ▶ High output loads
- ▶ High axial and radial load capacity
- ▶ Ultimate reliability
- ▶ Long service life
- ▶ Quiet running

UNICASE helical gear units (catalogue G1000)

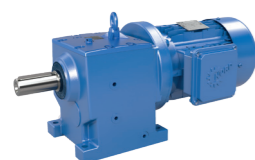

- ✓ Foot or flange mounted
- ✓ Long life, low maintenance
- ✓ Optimum sealing
- ✓ UNICASE housing

Size: 11
 Power: 0.12 – 160 kW
 Torque: 10 – 26.000 Nm
 Ratio: 1.35:1 – 14,340.31:1

NORDBLOC.1® 1- and 2-stage helical gear units (catalogue G1000)

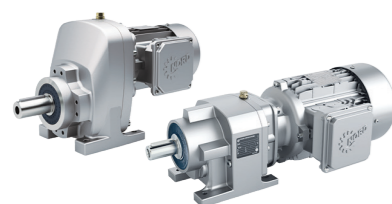

- ✓ Foot or flange-mounted
- ✓ Die-cast aluminium housing
- ✓ UNICASE housing
- ✓ Industry standard dimensions

Size: 13
 Power: 0.12 – 37 kW
 Torque: 30 – 3.300 Nm
 Ratio: 1.07:1 – 456.77:1

UNICASE parallel shaft gear units (catalogue G1000)

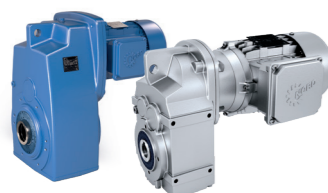

- ✓ Foot, flange or face mounted
- ✓ Hollow or solid shaft
- ✓ Compact design
- ✓ Cast iron or aluminium UNICASE housing

Size: 15
 Power: 0.12 – 200 kW
 Torque: 110 – 100.000 Nm
 Ratio: 4.03:1 – 15,685.03:1

UNICASE bevel gear units (catalogue G1000)

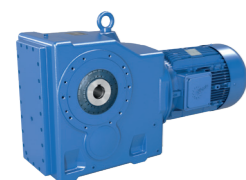

- ✓ Foot, flange or face mounted
- ✓ Hollow or solid shaft
- ✓ UNICASE housing

Size: 11
 Power: 0.12 – 200 kW
 Torque: 180 – 50.000 Nm
 Ratio: 8.04:1 – 13,432.68:1

NORDBLOC.1® 2-stage bevel gear units (catalogue G1014)



- ✓ Foot, flange or face mounted
- ✓ Hollow or solid shaft
- ✓ Aluminium housing

Size: 6
 Power: 0.12 – 9.2 kW
 Torque: 50 – 660 Nm
 Ratio: 3.03:1 – 70:1

UNICASE worm gear units (catalogue G1000)



- ✓ Foot, flange or face mounted
- ✓ Hollow or solid shaft
- ✓ UNICASE housing

Size: 6
 Power: 0.12 – 15 kW
 Torque: 93 – 3.058 Nm
 Ratio: 4.40:1 – 7.095,12:1

UNIVERSAL SI worm gear units (catalogue G1035)

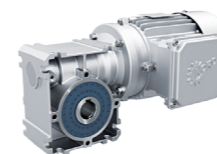

- ✓ Modular
- ✓ Universal mounting options
- ✓ Life-long lubrication
- ✓ IEC versio

Size: 5
 Power: 0.12 – 4.0 kW
 Torque: 21 – 427 Nm
 Ratio: 5.00:1 – 3.000,00:1

UNIVERSAL SMI worm gear units (catalogue G1035)

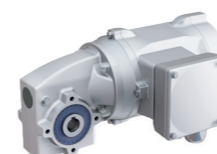

- ✓ Smooth surfaces
- ✓ Universal mounting options
- ✓ Life-long lubrication
- ✓ IEC version

Size: 5
 Power: 0.12 – 4.0 kW
 Torque: 21 – 427 Nm
 Ratio: 5.00:1 – 3000.00:1

DuoDrive – integrated geared motor concept



- ✓ High-efficiency IE5+ motor
- ✓ System efficiency up to 92%
- ✓ Results in a significant reduction of the TCO (Total Cost of Ownership) compared to other drive systems
- ✓ High power density
- ✓ Minimal noise emissions
- ✓ Simple plug-and-play commissioning
- ✓ Hygienic design (wash-down)
- ✓ Design: M1, M4, M5, M6

Sizes: 1
 Power: 0.35 – 3.0 kW
 Torque: 26 – 247 Nm
 Speed ratio: 3.24 – 18.1:1

Complete drive solutions from a single source

NORD is the only manufacturer that builds modular industrial gear units up to 282,000 Nm output torque with a one-piece block housing.

- ▶ UNICASE housing, no joints subject to torque
- ▶ All bearing points and sealing surfaces are machined in a single operation
- ▶ High precision axis alignment, quiet running
- ▶ Long life, low-maintenance
- ▶ Helical and bevel gear units

MAXXDRIVE® parallel gear units (catalogue G1050)

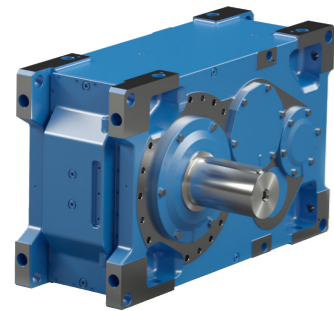

- ▶ Universal gear units
- ▶ 2- and 3-stage
- ▶ Multiple mounting and cooling options
- ▶ Modified bearing options for high radial and axial load capacity
- ▶ Compact design
- ▶ All installation positions

Size: 11
 Power: 1.5 – 6.000 kW
 Torque: 15.000 – 282.000 Nm
 Ratio: 5.54 – 30.000:1

MAXXDRIVE® right-angle gear units (catalogue G1050)

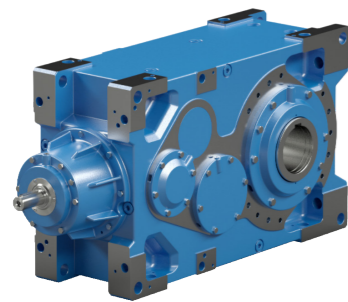

- ▶ Universal gear units
- ▶ 3- and 4-stage
- ▶ Multiple mounting and cooling options
- ▶ Modified bearing options for high radial and axial load capacity
- ▶ Compact design
- ▶ All installation positions

Size: 11
 Power: 1.5 – 2.115 kW
 Torque: 15.000 – 260.000 Nm
 Ratio: 12.61 – 30.000:1

MAXXDRIVE® XT right-angle gear units (T160-0011)

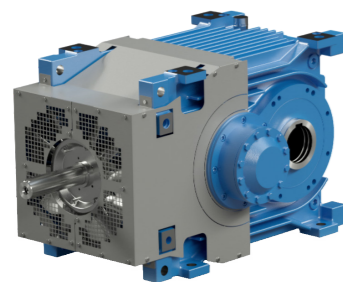

- ▶ 2-stage
- ▶ Thermally optimised gear units
- ▶ Integrated high power axial fan
- ▶ High powers with low speed ratios
- ▶ Optimised for horizontal installation orientation
- ▶ Ideal for applications such as belt or bucket conveyors

Size: 7
 Power: 22 – 2.100 kW
 Torque: 15.000 – 75.000 Nm
 Ratio: 6.14 – 22.91:1

Industrial gear unit modules

Optimally matched components form the basis of a wide variety of variants as well as great flexibility and short planning and assembly times. This enables the drive solutions to be individually tailored to the customer's requirements with short delivery times, even for large gear units.

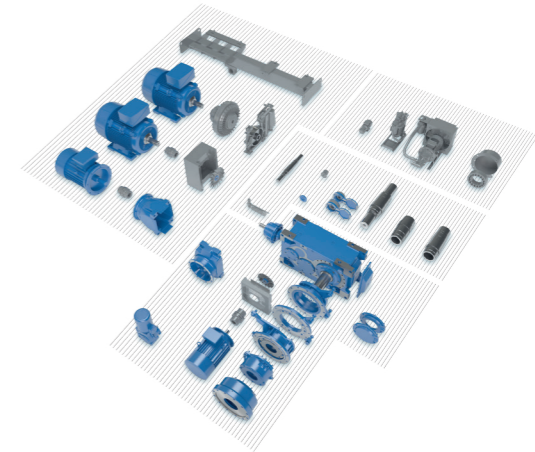

MAXXDRIVE® XD parallel gear units (flyer S1056)

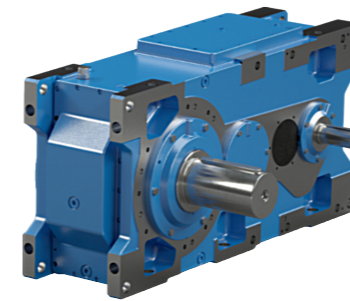

- ▶ 3- and 4-stage
- ▶ Housing with increased centre distance
- ▶ Inspection cover
- ▶ Housing optimised for downward radial loads
- ▶ Ideal for lifting equipment

Size: 5
 Power: 1,5 – 925 kW
 Torque: 15.000 – 112.000 Nm
 Ratio: 22,4 – 355:1

MAXXDRIVE® XJ right-angle gear unit

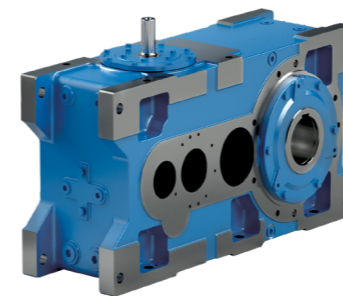

- ▶ 3-stage
- ▶ New input shaft position "J-Mount"
- ▶ Horizontal and vertical installation positions
- ▶ Modular
- ▶ Flexible

Size: 5
 Power: 5,5 – 1.275 kW
 Torque: 15.000 – 107.000 Nm
 Ratio: 12,5 – 100:1

MAXXDRIVE® drive systems (catalogue G1050)



- ▶ Complete drive systems consisting of the gear unit, motor and drive electronics
- ▶ Wide selection of other components, e.g. couplings, brakes, etc.
- ▶ Standardised solutions for rockers and base frames, e.g. for belt conveyors or bucket elevators, etc.
- ▶ Systems tailored to applications, e.g. agitators, hoists, extruders, etc.
- ▶ Individually adaptable

ATEX NORD geared motors and industrial gear units are also available in ATEX-certified

Complete drive solutions from a single source

NORD DRIVESYSTEMS develops its own motors and supplies them to all major markets throughout the world. Our own developments ensure a high level of independence from external suppliers and therefore provides our customers with the decisive advantage of short and highly dependable delivery times.

International energy efficiency standards

- ▶ Efficiency standard
 - ▶ IEC 60034-30
- ▶ Efficiency regulations
 - ▶ REGULATION (EU) 2019/1781
 - ▶ Ecodesign Directive 2009/125/EG
- ▶ Minimum efficiency
 - ▶ IE2 - motors
 - ▶ 0.12 kW to < 0.75 kW
 - ▶ Single phase motors >= 0.12 kW
 - ▶ 2-, 4-, 6- or 8-pole motors
 - ▶ IE3 - motors
 - ▶ 0.75 kW to < 75 kW
 - ▶ > 200 kW to 1000 kW
 - ▶ 2-, 4-, 6- or 8-pole motors
 - ▶ IE4 - motors
 - ▶ >= 75 kW to <= 200 kW
 - ▶ 2-, 4- or 6-pole motors
 - ▶ IE5 - motors
 - ▶ TEFC: 0.35 to 4.00 kW
 - ▶ TENV: 0.35 kW - 2.2 kW
- ▶ Variable speed drive: IE2
 - ▶ 0.12 kW to 1000 kW

IE2

IE3

IE4

IE5+

In combination with motor and motor control systems in accordance with Ecodesign directive EN50598

IES2

Energy-saving motors (catalogue M7000 and M7002)

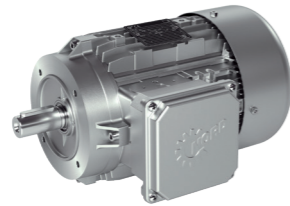

Switchable pole motors (catalogue M7000)

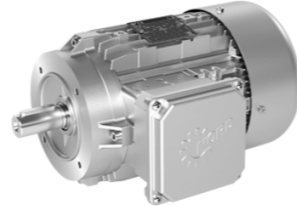

Single-phase motors (catalogue M7000)

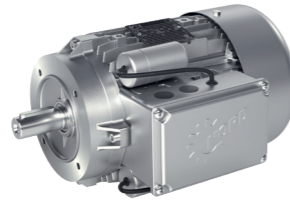

Smooth motors (catalogue M7010)



Explosion-protected motors Gas atmospheres (catalogue G2122)

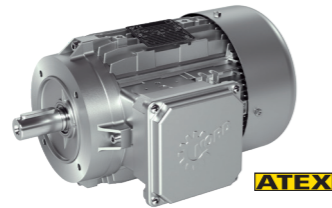

Explosion-protected motors Dust atmospheres (catalogue G2122)

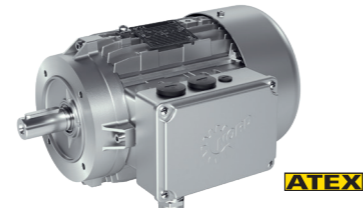

IE5+ synchronous motor

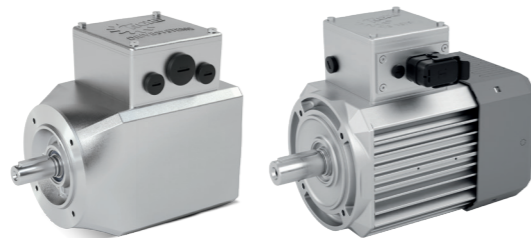

We have the drive units for intelligent processes: Networked – Autonomous – Scalable. Intelligent drives from NORD DRIVESYSTEMS play an important role in highly networked systems in order to advance the so-called fourth industrial revolution which is based on the extensive exchange of information on all levels.

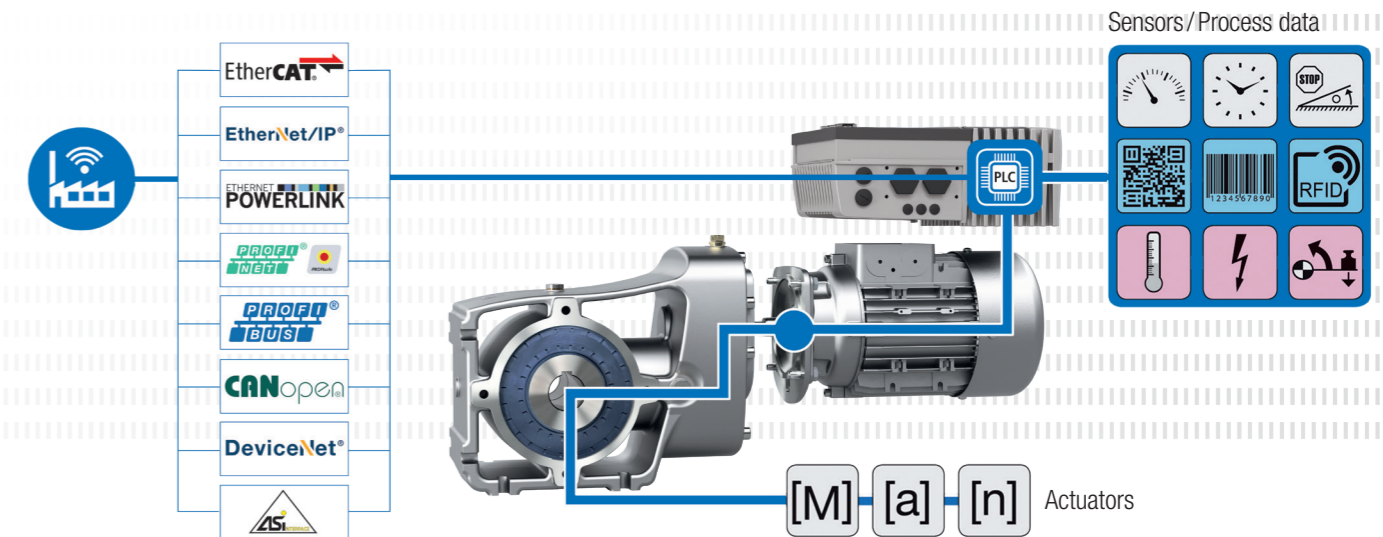

NORD DRIVESYSTEMS – INDUSTRY 4.0 READY!

"NORD 4.0 READY!" means that NORD drive units are networked, autonomous and scalable. The key to this are the frequency inverters with their powerful processors and comprehensive equipment, interfaces and functions. They not only monitor themselves and the motor, but also their effect on the load situation in the segments of the plant and beyond.

The integrated PLC processes data from sensors and actuators and if necessary initiates a control sequence and communicates high quality drive and application data to the control centre and other networked components.

For example, intelligent sequence controls can enable the drive unit to independently decide on a branch position and act accordingly. The drive units can also communicate with each other: "Attention, I am sending a package in your direction. Start your conveyor belt." A slave drive can synchronise to a master for a particular task and then return to normal operation. Hundreds of typical functions are saved as parameter sets and can be simply adopted.

As a result, the frequency inverter can coordinate both simple and complex applications independently from the plant control system, and can respond to changes to the process or remedy many process faults independently without external intervention.

Complete drive solutions from a single source

NORD DRIVESYSTEMS produces frequency inverters and motor starters for the necessary power electronics. Inverter solutions are available for conventional control cabinet installations as well as for decentralised, fully-integrated drive units.

SK 135E NORDAC *START* motor starters (catalogue E3000)

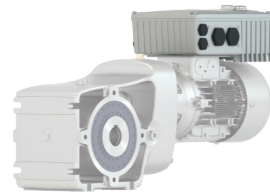

- ✓ Integrated electronic brake rectifier
- ✓ Reversing starter with soft start function
- ✓ Consistent parameter structure

Size: 2
Voltage: 3~ 200 – 240 V, 3~ 380 – 500 V
Power: 0.12 – 3 kW or up to 7.5 kW

SK 180E NORDAC *BASE* frequency inverters (catalogue E3000)

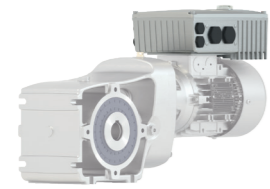

- ✓ Stand-alone operation
- ✓ Sensorless current vector control (ISD control)
- ✓ 4 parameter sets
- ✓ Integrated PLC

Size: 2
Voltage: 1~ 110 – 120 V, 1~ 200 – 240 V, 3~ 200 – 240 V, 3~ 380 – 500 V
Power: 0.25 – 2.2 kW

SK 200E NORDAC *FLEX* frequency inverters (catalogue E3000)

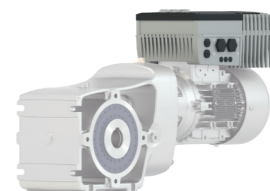

- ✓ Energy saving function
- ✓ Integrated PLC
- ✓ Integrated POSICON positioning control

Size: 4
Voltage: 1~ 110 – 120 V, 1~ 200 – 240 V, 3~ 200 – 240 V, 3~ 380 – 500 V
Power: 0.25 – 22 kW

SK 250E NORDAC *LINK* Feldverteiler (catalogue E3000)



- ✓ Frequency inverter or motor starter
- ✓ PLC functionality for drive-integrated functions
- ✓ All connections in plug-in version for easy commissioning and maintenance

Size: 2
Voltage: 3~ 380 – 500 V
Power: Frequency inverters 0.75 – 7.5 kW, Motor starter 0.12 – 3 kW

SK 500E NORDAC *PRO* frequency inverters (catalogue E3000)



- ✓ Stand-alone operation
- ✓ Sensorless current vector control (ISD control)
- ✓ 4 parameter sets
- ✓ Integrated PLC

Size: 11
Voltage: 1~ 110 – 120 V, 1~ 200 – 240 V, 3~ 200 – 240 V, 3~ 380 – 480 V
Power: 0.25 – 160 kW

SK 500P NORDAC *PRO* frequency inverters (catalogue E3000)



- ✓ Precise current vector control with high overload reserves for operating asynchronous and synchronous motors
- ✓ Universal interface for real time Ethernet
- ✓ Integrated PLC for drive-related functions even in the basic device

Size: 5
Voltage: 1~ 200 – 240 V, 3~ 380 – 480 V
Power: 0.25 – 22 kW

NORDAC *ON/ ON+*

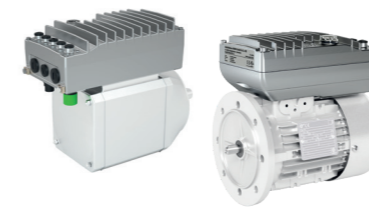

- ✓ Optimised by focusing
- ✓ Very compact design
- ✓ Plug & Play for fast IBN
- ✓ Integrated Ethernet interface

Size: 3
Mains voltage: 3 ~ 400 V
Power: 0.37 – 3.0 kW

NORDAC *ACCESS BT*



- ✓ Stand-alone parameter memory
- ✓ Data transfer to PC via USB
- ✓ Bluetooth interface for inverter and NORDCON APP
- ✓ Can be plugged in or disconnected during operation

NORDCON *APP*



- ✓ Dashboard-based visualisation for drive monitoring and fault diagnosis
- ✓ Individually configurable oscilloscope function for drive analysis
- ✓ Parameterisation with Help-function and rapid access to parameters
- ✓ Backup and recovery function for simple handling of drive parameters



The NORDCON APP and NORDAC ACCESS BT – a mobile commissioning and service solution for all NORD drives.

Complete drive solutions from a single source

In condition monitoring, operating and status data are regularly or continuously recorded in order to optimise the reliability and efficiency of the plant and machinery. Important information for predictive maintenance can be derived from the data analysis.

The objective is to maintain machines and plants proactively, to reduce downtimes and to increase the efficiency of the entire plant.

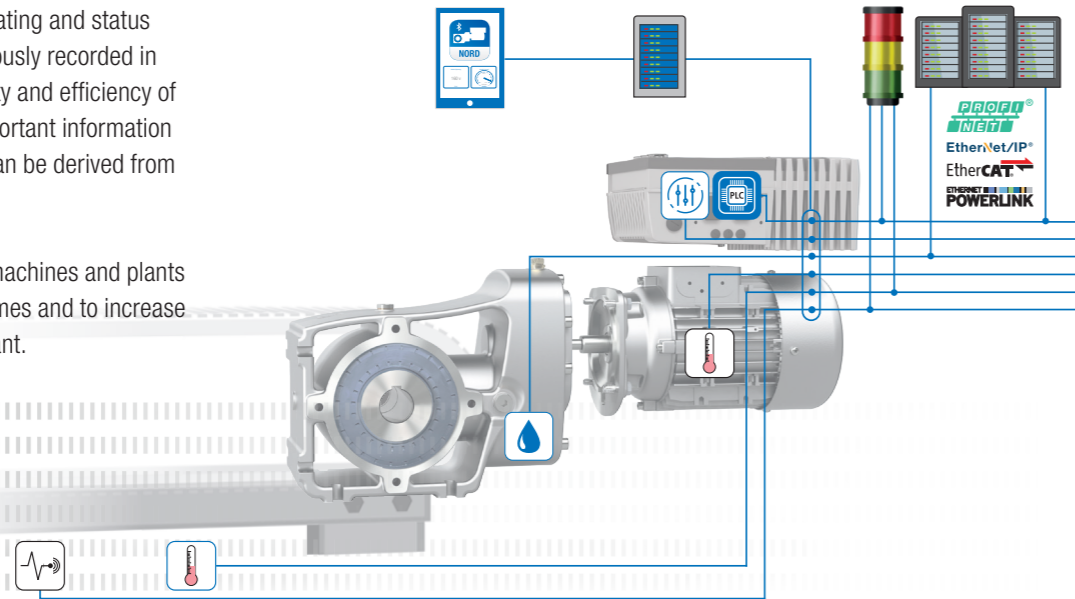

- System vibration sensor**

 - ▶ NORD qualified sensors
 - ▶ Connection of customised sensors (analogue / digital)
- System vibration sensor**

 - ▶ PT1000-based motor temperature sensor
 - ▶ Ambient or system temperature
- Oil change**

 - ▶ Determination of the optimal time for oil change on the basis of the virtual oil temperature
 - ▶ The algorithm is executed in the internal PLC
- Drive parameters**

 - ▶ Readout of drive system parameters
 - ▶ Basis for virtual sensors
- Integrated PLC**

 - ▶ Pre-processing of drive-specific parameters and sensors related to the drive
 - ▶ Evaluation of drive conditions
- Beacon signal**

 - ▶ Local display of drive conditions
 - ▶ Scalable display
- Local data management**

 - ▶ Processing of drive data for drive and system analysis
 - ▶ Condition monitoring
- Local dashboard**

 - ▶ Display of drive and system data
- Higher level PLC**

 - ▶ Processing of condition monitoring information by the customer
 - ▶ Combination of the collected condition monitoring data with the process data

Drive-based approach

Information from condition monitoring can be transferred to predictive maintenance.

- ▶ Sensorless determination of the optimal oil change time based on virtual oil temperature
- ▶ Provision of data to the customer via all common interfaces
- ▶ Pre-processing of drive data in the integrated PLC

Temperature curve of the oil in the gear unit

- ▶ Gear unit parameters and specific operational parameters make it possible to precisely calculate the oil change time.
- ▶ No physical temperature sensor, as the virtual sensor continuously calculates the present oil temperature.
- ▶ The NORD solution is based on the fact that the oil temperature is a key factor for oil ageing in gear units.
- ▶ The NORD frequency inverter is used as an evaluation unit: the algorithm is executed in the internal PLC.

NORD DRIVESYSTEMS modular service concept



With its modular service concept NORD DRIVESYSTEMS provides solutions for maintaining availability and conserving the value of the drive technology. It provides various services in the form of compact modules, which range from assistance in commissioning, specific maintenance packages, and from on-site analysis to estimate repair costs. In addition, there are modernisation or optimisation measures. Last-not-least, operators can qualify their employees with various training sessions.

NORD service modules

- ▶ Installation and commissioning
- ▶ Periodic maintenance and status monitoring
- ▶ Repair, maintenance or replacement
- ▶ Spare parts logistics
- ▶ Product instruction and training
- ▶ Individual contracts
- ▶ 24/7 emergency service
- ▶ Modernisation and extension

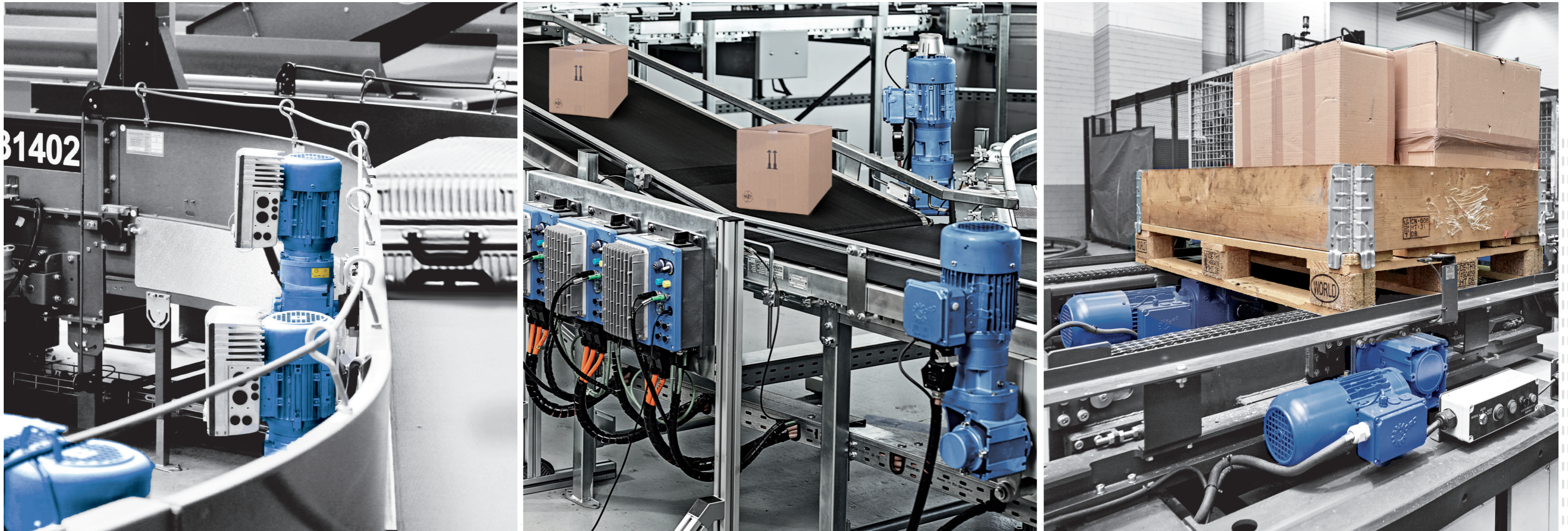

LogiDrive[®]

Solution space for airport, post & parcel and warehouse

Our customers have very individual applications and requirements. We provide tried and tested safe solutions for many applications in the logistics industry. Whether your focus is on efficiency, a small number of variants, software solutions or predictive maintenance – we have the right solution for you. We call this our solution space. Tried and tested solutions for common applications with different objectives. We are offering you tried and tested solutions for the **airport, post & parcel** and **warehouse** sectors. You have the possibility to directly apply this in your systems or to adjust your solution individually using our comprehensive modular system.



LogiDrive
solution space

EN

Headquarters:

Getriebebau NORD GmbH & Co. KG

Getriebebau-Nord-Str. 1

22941 Bargteheide, Germany

T +49 4532 289 0,

F +49 4532 289 2253

info@nord.com