

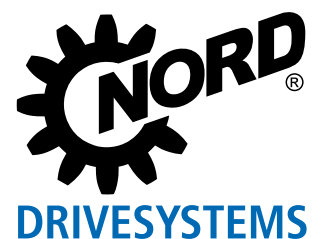

EN
NORDAC
Electronic drive technology
E3000

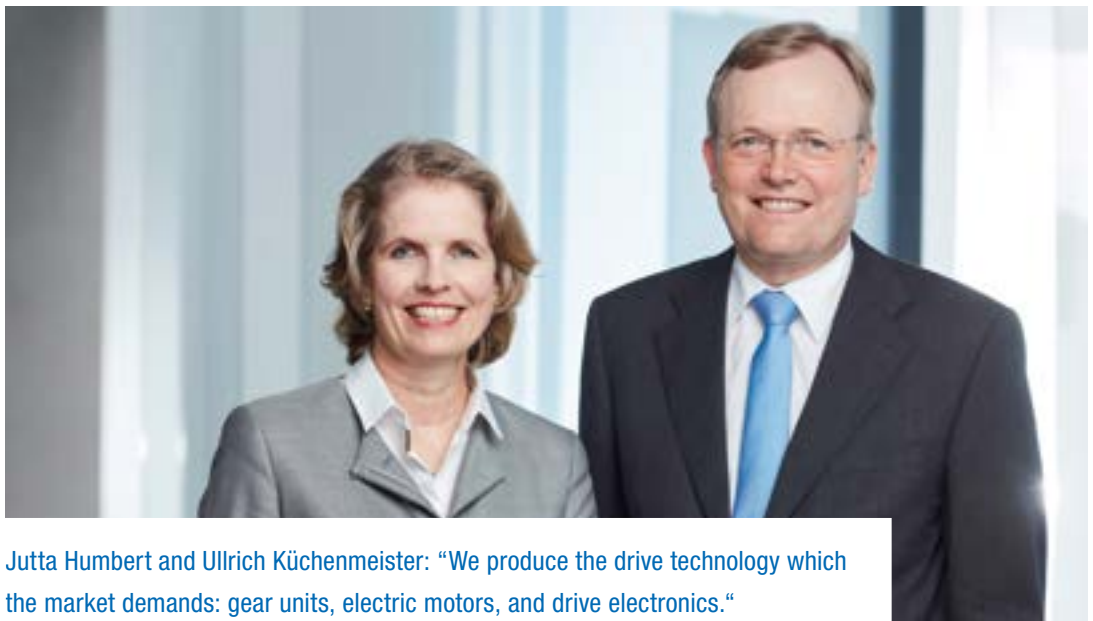



Jutta Humbert and Ullrich Küchenmeister: “We produce the drive technology which the market demands: gear units, electric motors, and drive electronics.”

Since 1965, our family business has developed into one of the world's leading complete supplier of mechanical and electronic drive technology. We supply individual drive solutions. Our innovations set global standards.

Our focus is to provide you with added value.

Since 1965 we have developed and manufactured all the major components for our mechanical and electronic drive technologies (gear units, electric motors and drive electronics). This wide-ranging in-house design and production capability allows us to offer our customers individual drive solutions. Our extensive manufacturing, test and research facilities feature cutting-edge technology and equipment.

With our know-how and experience, we meet the most stringent quality demands. The UNICASE concept, which we developed in 1981 quickly became the international standard for the manufacture of gear unit housings. Today, the focus of our innovation is on intelligent, functionally variable drive technology for Industry 4.0 applications.

- ▶ Subsidiaries in 36 countries
- ▶ Many agencies worldwide
- ▶ Fast and reliable service in the national language, thanks to local contact partners
- ▶ Production facilities at locations in Germany, Italy, Poland, the USA and China
- ▶ Latest technology for the production of gear units, motors and drive electronics
- ▶ Highest quality standards at all locations
- ▶ Dependability, flexibility and always with customer benefits in view

We are regarded as the technological leaders in the development and production of motors, gear units and drive electronics, and work to the highest quality standards. To dependably meet these standards, we have set up a global network of production facilities for all drive components. Our headquarters, with its technology and logistics centre, and administration offices are located in Bargteheide near

Hamburg. In addition, we have seven production facilities in Germany, Italy, Poland, the USA and China. Whether gearwheels, shafts, housings, motors or drive electronics - all components are produced in our own production facilities with great dependability and flexibility. We therefore offer our customers throughout the world the best possible quality, regardless of the location and circumstances.



HEADQUARTERS OF GETRIEBBAU NORD IN BARGTEHEIDE NEAR HAMBURG, GERMANY
RESEARCH AND DEVELOPMENT, LOGISTICS CENTRE



AURICH IN LOWER SAXONY, GERMANY
FREQUENCY INVERTER PRODUCTION

Drive Solutions

Drive Electronics

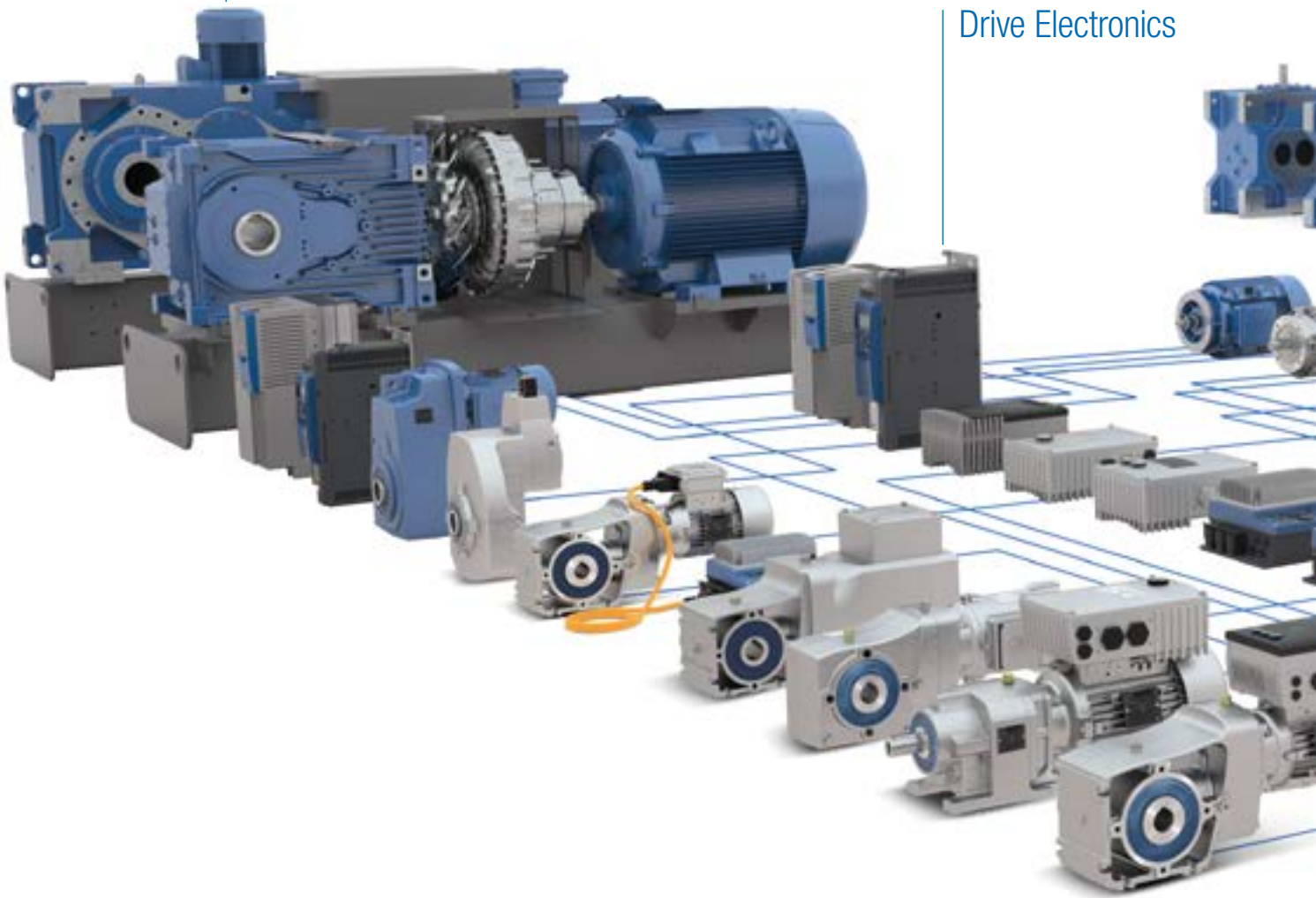

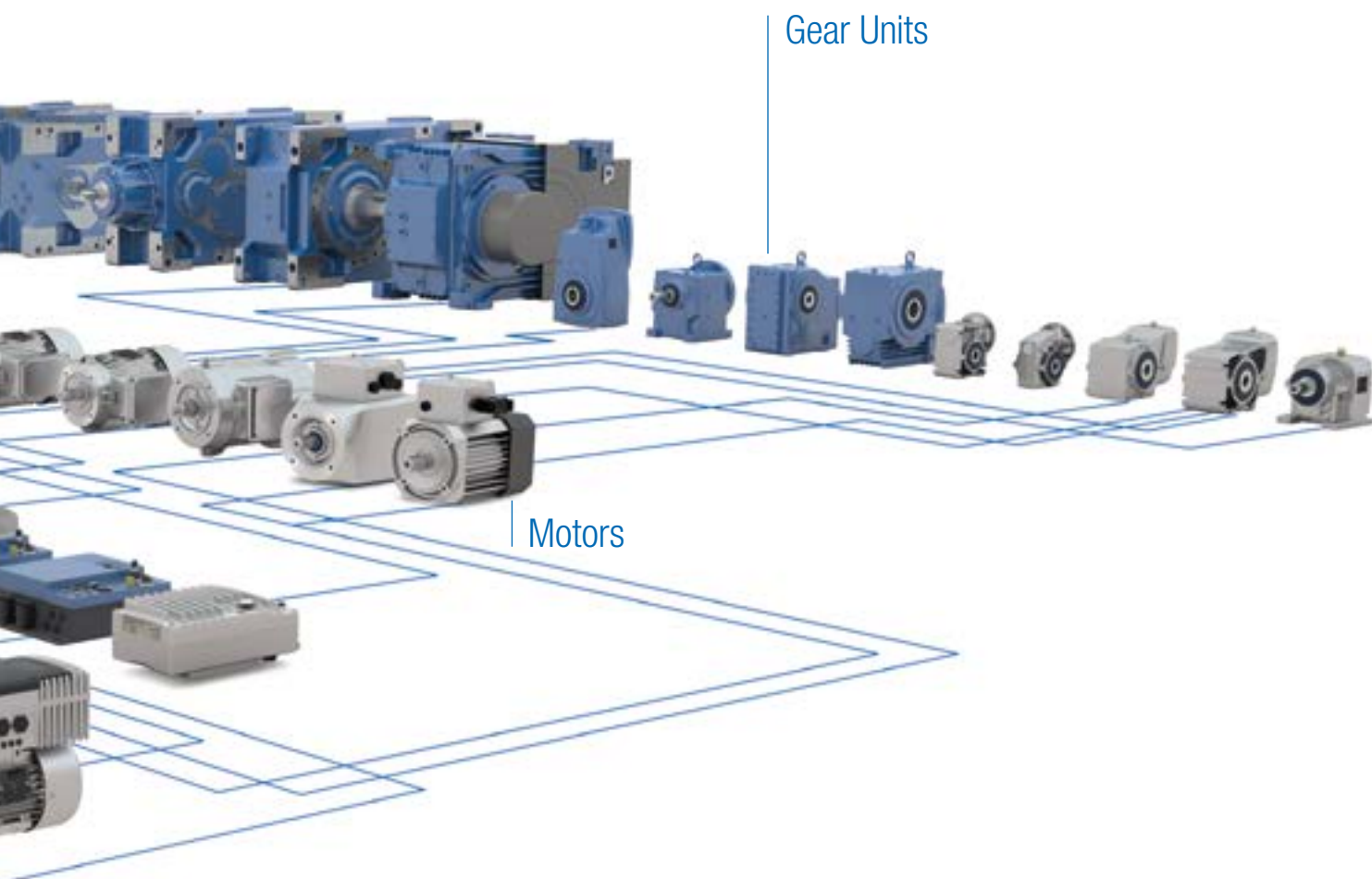

Gear Units

Motors

ATEX

Our products are available in ATEX certified versions.

An optimum and individual drive solution can therefore be created using the modular NORD system consisting of the gear unit, motor and drive electronics. The modular products are perfectly matched and can be combined in many variants. In addition, we offer planning, project management, installation, and service from a single source. If required, industry solutions can be configured as a

complete logistics package, programmed and ready for use. Each modular NORD product combines: highest product quality, short planning and assembly times, high delivery availability, and a good price/performance ratio. Our products are also available in ATEX certified versions.

Geared motors



UNICASE helical gear units

- ▶ Foot or flange mounted
- ▶ Long life, low-maintenance
- ▶ Optimum sealing
- ▶ UNICASE housing

Sizes	11
kW	0.12 – 160
Nm	10 – 26,000
i	1.35:1 – 14,340.31:1



NORDBLOC.1® helical gear units

- ▶ Foot or flange mounted
- ▶ Die-cast aluminium housing
- ▶ UNICASE housing
- ▶ Industry standard dimensions

Sizes	13
kW	0.12 – 37.0
Nm	30 – 3,300
i	1.07:1 – 456.77:1



BLOCK Flachgetriebe

- ▶ Foot mounted, flange mounted or face mounted
- ▶ Hollow or solid shaft
- ▶ Compact design
- ▶ UNICASE housing

Sizes	15
kW	0.12 – 200
Nm	110 – 100,000
i	4.03:1 – 15,685.03:1



NORDBLOC.1® bevel gear units

- ▶ Foot mounted, flange mounted or face mounted
- ▶ Hollow or solid shaft
- ▶ UNICASE housing

Sizes	6
kW	0.12 – 9.2
Nm	50 – 660
i	3.03:1 – 70:1



UNICASE helical worm gear units

- ▶ Foot mounted, flange mounted or face mounted
- ▶ Hollow or solid shaft
- ▶ UNICASE housing

Sizes	6
kW	0.12 – 15.0
Nm	93 – 3.058
i	4.40:1 – 7,095.12:1



UNIVERSAL SI worm gear units

- ▶ Modular
- ▶ Universal mounting
- ▶ Lubricated for life

Sizes	5
kW	0.12 – 4.0
Nm	21 – 427
i	5.00:1 – 3,000.00:1



UNICASE parallel gear units

- ▶ Foot mounted, flange mounted or face mounted
- ▶ Hollow or solid shaft
- ▶ UNICASE housing

Sizes	11
kW	0.12 – 200
Nm	180 – 50,000
i	8.04:1 – 13,432.68:1



UNIVERSAL SMI worm gear units

- ▶ Smooth surfaces
- ▶ Lubricated for life

Sizes	5
kW	0.12 – 4.0
Nm	21 – 427
i	5.00:1 – 3,000.00:1



MAXXDRIVE® industrial gear units

- ▶ All bearing points and sealing surfaces are machined in a single operation
- ▶ UNICASE housing, no joints subject to torque
- ▶ High-precision axis alignment, quiet running
- ▶ Long life, low-maintenance
- ▶ Gear ratio range 5.54 to 400:1 with the same foot dimensions
- ▶ Helical and bevel gear units
- ▶ Integrated high-efficiency axial fan (MAXXDRIVE® XT only)

	MAXXDRIVE®	MAXXDRIVE® XT
Sizes	11	7
kW	1.5 - 6,000	22.0 - 2,100
kNm	15 - 282	15 - 75
i	5.54:1 - 30,000:1	6.14:1 - 22.91:1



DuoDrive

- ▶ IE5+ motor and a single-stage helical gear unit in one housing
- ▶ Extremely high system efficiency
- ▶ Compact wash-down design

Sizes	2
kW	0.35 - 3.0
Nm	5 – 247
i	3.24 – 18.1 : 1

NORD is the only manufacturer that produces modular industrial gear units with an output torque of up to 282,000 Nm in a one-piece UNICASE housing.

ATEX

NORD gear motors and industrial gear units are also available in ATEX certified versions.

Drive electronics

Functions

- ▶ High precision regulation with current vector control
- ▶ Compatible with all common bus systems
- ▶ 4-quadrant operation
- ▶ PLC functionality for drive-related functions
- ▶ Energy-saving function for partial load operation
- ▶ Control and parameterisation tools and simple parameter structure
- ▶ Integrated line filter for compliance with EMC regulations
- ▶ Operation of synchronous and asynchronous motors
- ▶ Control and closed loop regulation
- ▶ POSICON – integrated positioning mode and synchronisation
- ▶ STO and SS1 – integrated functional safety
- ▶ Integrated brake rectifier for motor brake control

Advantages

- ▶ Scalable functionality – flexibility of equipment and function
- ▶ High torque capability for all drive applications
- ▶ Simple commissioning and operation

NORD drive electronics are available in ATEX certified versions.



NORDAC ON:
Decentralised
frequency inverter SK 300P

Decentralised drive unit specially developed to meet the special requirements of horizontal conveyor technology, as well as for the interaction with the new IE5+ synchronous motor

Kenndaten:

- ▶ Power range up to 3.7 kW
- ▶ Wall or motor mounting
- ▶ IP55, IP66, IP69



NORDAC FLEX:
Decentralised
frequency inverter SK 200E

Decentralised drive unit with versatile installation options. Simple commissioning and maintenance through extensive plug-in capability and simple parameter transfer via EEPROM.

Nominal ratings:

- ▶ Power range up to 22 kW
- ▶ Wall or motor mounting
- ▶ IP55, IP66



NORDAC BASE:
Decentralised
frequency inverter SK 180E

Economical decentralised version for simple drive applications. Low installation costs as well as robust design for simple installation outside the control cabinet.

Nominal ratings:

- ▶ Power range up to 2.2 kW
- ▶ Wall or motor mounting
- ▶ IP55, IP66



NORDAC PRO:
Control cabinet inverter
SK 500E

The inverter for all drive applications. Proven technology, large power range and capable of functional expansion with plug-in option modules. Optimised heat dissipation thanks to the variable cooling concept.

Nominal ratings:

- ▶ Power range up to 160 kW
- ▶ Control cabinet installation
- ▶ IP20



NORDAC PRO:
Control cabinet inverter
SK 500P

The next generation of control cabinet inverters. Compact size, innovative and extremely flexible communication and interface concept, functional expansion with optional modules.

Nominal ratings:

- ▶ Power range up to 22.0 kW
- ▶ up to 160 kW, in preparation
- ▶ Control cabinet installation
- ▶ IP20

Motors



Energy-saving motors



Switchable pole motors



Single-phase motors



Smooth motors



ATEX

Explosion protected motors,
gas atmospheres



ATEX

Explosion protected motors,
dust atmospheres



Special features

- ▶ Motors developed and produced by NORD.
- ▶ We produce energy-efficient products for all parts of the world.
- ▶ Products available at all international locations.



NORDAC START:
Motor starter SK 135E

The decentralised starter for all types of soft starting. With integrated motor protection and reversing function for flexible integration into the system.

Nominal ratings:

- ▶ Power range up to 7.5 kW
- ▶ Wall or motor mounting
- ▶ IP55, IP66



NORDAC LINK:
Frequency inverter
SK 250E-FDS

The field distributor for flexible, decentralised installation. Flexibility of equipment and function – free configurability according to requirements and the application. Available as inverter and starter.

Fast commissioning through high level of plug-in capability. Simple servicing of the system through integrated maintenance switch and local manual control facility.

Nominal ratings:

- ▶ Power range up to 7.5 kW
- ▶ Wall mounting
- ▶ IP55, IP65



NORDAC LINK:
Motor starter
SK 155E-FDS

Nominal ratings:

- ▶ Power range up to 3 kW
- ▶ Wall mounting
- ▶ IP55, IP65

Why drive solutions from NORD DRIVESYSTEMS are your best choice

For more than 50 years we have provided our customers with extensive advice and planning security for the planning and implementation of standardised or customised drive solutions with electronic drive technology.

- ▶ NORD provides everything from a single source. All components such as gear units, motors and drive electronics are optimally matched.
- ▶ NORD provides competent local support throughout the world for the planning, design and integration of suitable drive technology.
- ▶ NORD supplies pre-assembled drive systems which are simple and easy to install and maintain.
- ▶ Satisfied customers from all over the world give you confidence in your decision for NORD



Experience, competence and innovation over more than 30 years
NORD Electronic DRIVESYSTEMS GmbH,
a member of the
NORD DRIVESYSTEMS Group

In addition to excellent quality and reliability, drive solutions from **NORD DRIVESYSTEMS** also feature a great depth of production. The drive specialist produces all quality-relevant components in its own facilities. At the beginning of the 1980s, **NORD** started to produce electronic drive technology in Aurich, Lower Saxony. Over the years, the range of inverters, motor starters and electronics was continually expanded and now includes electronic drive technology up to 160 kW. The production location has also been continually extended. Thus, up to 400,000 units can be produced per year.



Introduction
NORDAC PRO SK 500P
NORDAC PRO SK 500E
NORDAC LINK
NORDAC ON
NORDAC FLEX
NORDAC BASE
NORDAC START
Accessories

The inner values are what counts

Extensive basic equipment



User friendliness

- ▶ Easy adaptation to bus communication systems with optional hardware/software options.
- ▶ Quick and simple diagnostics via easily visible LED indicators
- ▶ Technology units available for display, operation and parameterisation
- ▶ Clear display by large LCD screen in 14 languages (optional)
- ▶ Simple operation and parameterisation through logical parameter structure and intuitive layout of control elements
- ▶ Variants for control cabinet installation, hand-held technology, or direct mounting on the inverter available (only NORDAC PRO)
- ▶ Wireless interface for operation and parameterisation with mobile terminal devices available



Protection and safety functions

- ▶ Frequency inverter protected through
 - ▶ Overvoltage monitoring
 - ▶ Temperature monitoring
 - ▶ Excess current monitoring
- ▶ Communication monitoring
 - ▶ Timeout functions
- ▶ System protection through
 - ▶ Overload monitoring
 - ▶ Thermistor evaluation
 - ▶ Motor temperature monitoring
- ▶ Functional safety
 - ▶ Safe torque switch-off STO
 - ▶ Safe stop SS1-t
 - ▶ Safe speed SLS, SOS
 - ▶ Secure bus communication



(not available in all series)

Inner values are what count

Extensive basic equipment

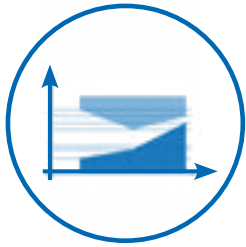

Load monitor

- ▶ Monitoring of load torque depending on the output frequency
- ▶ Individual adaptation of load monitoring to protect the system from overload in particular frequency ranges



Energy-saving function

- ▶ Maximum efficiency in partial load operation
- ▶ Reduced operating costs due to energy savings of up to 60%
- ▶ Simple adjustment

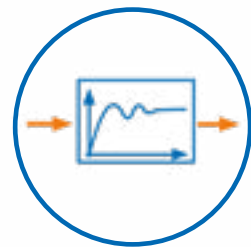

PI Process controller/PID controller

- ▶ Feedback and evaluation of actual values for implementation of closed-loop control circuit (e.g. flow or dancer control)
- ▶ P and I components can be set separately



Master/slave operation

- ▶ Control of one or more slave inverters by a master inverter
- ▶ Communication via USS or CANopen with control word and setpoint values

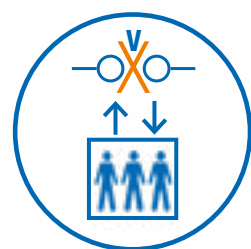

Evacuation run

- ▶ Evacuation run possible if the main supply fails
- ▶ Emergency operation with low DC voltage from UPS (e.g. battery) possible

(not available in all series)





Lifting gear functions

- ▶ High-precision current vector control for rapid and precise load take-up
- ▶ Integrated brake chopper to divert generated energy to a brake resistor (brake resistor optional)
- ▶ Brake management for optimum control of an electromechanical holding brake for wear-free brake actuation



Encoder feedback (Servo mode)

- ▶ High-precision speed regulation
- ▶ Highest possible acceleration due to direct feedback of the actual speed characteristics to the frequency inverter and therefore also:
 - ▶ Full torque down to standstill (speed 0)
 - ▶ Digital speed controller with wide range of setting



(not available in all series)



Operation without encoder of PMSM synchronous motors

- ▶ High-precision speed control without incremental encoder (openloop)
- ▶ Maximum acceleration



Link circuit coupling

- ▶ Coupling of the link circuits of multiple frequency inverters
- ▶ Energy-saving effect with balanced motor and generator operation
- ▶ Elimination of brake resistors possible

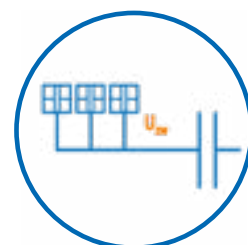

(not available in all series)

NORDAC frequency inverters for CO₂ reduction:



Realistic speed adjustment

A realistic speed adjustment of drives in the process may save lossy mechanical power control methods such as throttle valves or bypass lines in pump systems. Regulated by a frequency inverter, the motor provides the speed exactly needed by the system, saving additional energy, operational costs and protecting the environment. For this purpose, NORD offers different frequency inverter systems that can be integrated in almost all system topologies. The customer can choose between conventional installation technologies for the control cabinet or – for decentralised use – mounted on or close to the motor to be controlled.

NORD frequency inverters

– whether motor-integrated, wall-mounted or installed in the control cabinet – have high efficiencies and comply with the current energy efficiency regulation IE2. In the devices' technical documentation, NORD indicates the power loss values for several operating points. The advantage is that the customer is now provided with general technical data as well as characteristics for different operating points. For the first time, it is thus possible to include the individual workload of the driven machine into the selection of the most suitable frequency inverter.



Introduction
NORDAC PRO SK 500P
NORDAC PRO SK 500E
NORDAC LINK
NORDAC ON
NORDAC FLEX
NORDAC BASE
NORDAC START
Accessories

Motors in the partial load range

The fact that the drive technology within a machine is oversized is widespread. This is why reasons such as safety factors, efforts to standardise or dynamic characteristics during system operation often cause the motor to operate only occasionally in nominal operation, but primarily in the partial load range. The optimum efficiency of an asynchronous motor is, however, only achieved around its nominal operating point. For speeds and powers below the nominal operating point, its efficiency significantly decreases. Here too, the frequency inverter can help: It recognises the workload situation and, after a short time in the partial load range, lowers the motor magnetisation to the reduced, required level. This reduces motor losses, and the efficiency is actively optimised. For higher load requirements, an automatic readjustment takes place.



Definition of environmentally friendly drive technology

Operation of modern electric motors like the IE4 or IE5+ motors from Getriebebau NORD is only possible in combination with a frequency inverter. The efficiencies of these synchronous motors are considerably higher than with asynchronous motors – not only in the nominal operating point, but also beyond a wide speed and power range.

NORDAC frequency inverters and IE4/IE5+ high-efficiency motors from NORD have been jointly developed and perfectly matched. The achieved optimum of modern drive technology also offers the potential to quickly pay for itself through energy cost savings. This is why the frequency inverters and IE4/IE5+ motors from NORD are the right answer to the question of environmentally friendly drive technology for modern engineering.



Condition monitoring for predictive maintenance

Condition monitoring for predictive maintenance

With condition monitoring, drive and status data is recorded periodically or continuously in order to optimise operational safety and efficiency of machines and systems. Condition monitoring can provide important information for predictive maintenance. The objective is to maintain machines and plants proactively, to reduce downtimes and to increase the efficiency of the entire plant.

Customer benefits

- ▶ Detection and avoidance of impermissible operating states at an early stage
- ▶ Status oriented maintenance replaces time-based maintenance
- ▶ Plannable machinery and plant downtimes based on real drive and process data
- ▶ Reduction of service and material costs
- ▶ Longer service life of components and machines
- ▶ Increase in system availability
- ▶ Avoidance of unplanned downtimes
- ▶ Plannable and cost-optimised maintenance

Condition Monitoring

The **INDUSTRIAL INTERNET of THINGS (IIoT)** focuses on use of the internet in industrial processes and procedures. **IIoT** aims to increase operational efficiency, reduce costs and speed up processes. Sensors and sensor data play a central role to provide the basis for condition monitoring and predictive maintenance.

- ▶ Condition monitoring solutions for predictive maintenance systems integrated into the frequency inverter
- ▶ System is **IIoT** / INDUSTRY 4.0 READY!
- ▶ Available for decentralised and control cabinet solutions

Sensors

- ▶ Interface for digital/analogue sensors
- ▶ Virtual sensors – The integrated PLC can calculate the optimal oil change time

Communication interfaces

- ▶ Threshold values or general status information can be communicated externally (via PROFINET IO and EtherNet/IP)

Integrated PLC

- ▶ Local pre-processing of data with the integrated PLC
- ▶ Pre-processing of threshold values

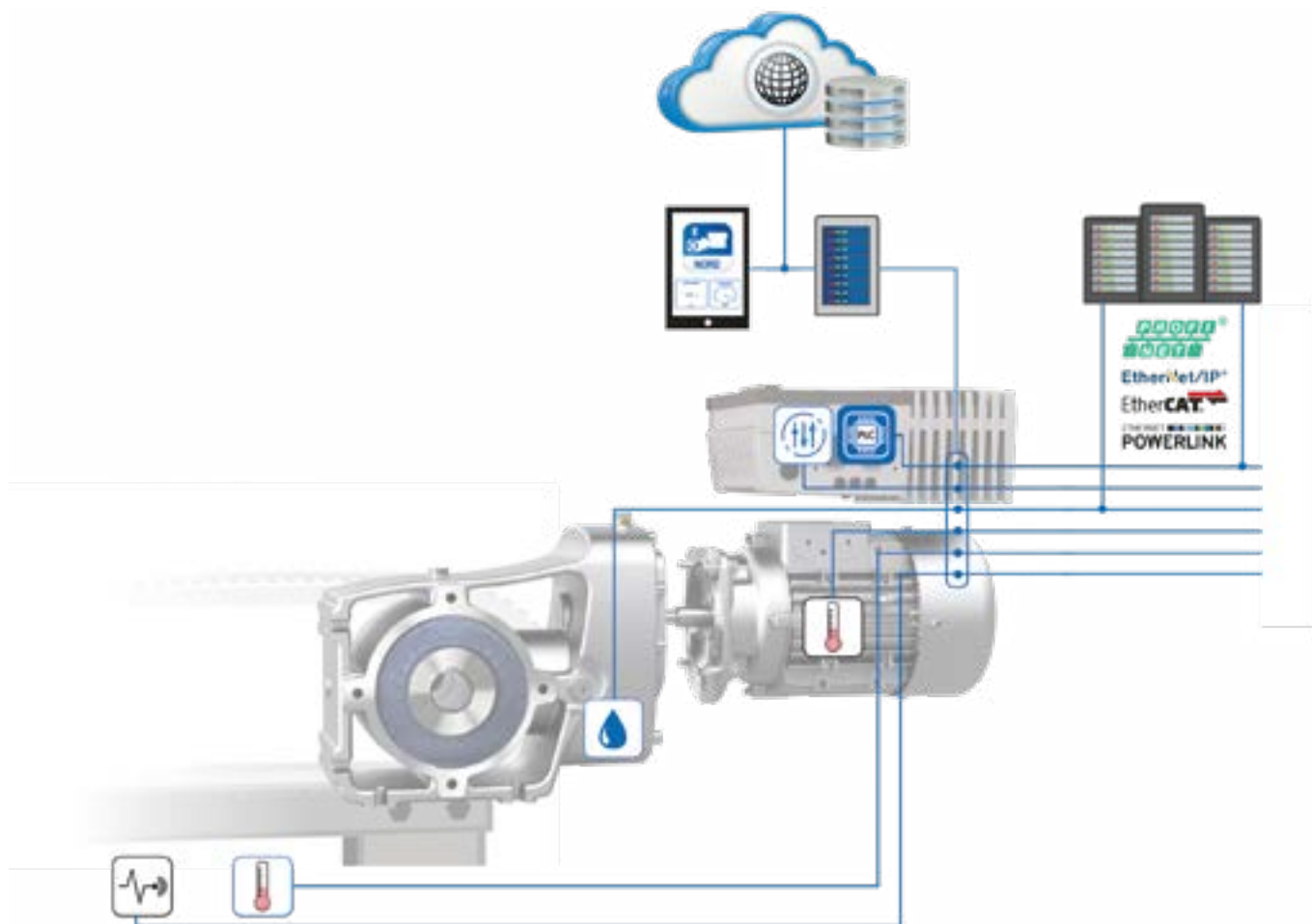

Function range

A series of three function ranges is available for condition monitoring (CM). The NORD **SmartOilChange** (SOC) function is available as an option.

CM1

CM1 includes the transfer of selected drive information parameters from the frequency inverter to a database in a local industrial computer (IPC). The IPC provides the additional opportunity to collect all drive information parameters and to pass them on to a customer cloud. The frequency inverter's integrated PLC is not used. An Ethernet interface in the frequency inverter is necessary to transfer the data to the local IPC.

CM2

CM2 additionally uses the frequency inverter's integrated PLC for threshold-based evaluation of external sensors (e.g. vibration sensor and motor temperature) or drive information parameters.

CM3

CM3 provides visualisation of the data for each drive in a proprietary NORD dashboard.

SOC

The optional SOC function enables determination of the optimum oil change time on the basis of the virtual oil temperature. The algorithm is executed in the integrated PLC. At present this function is available for 2-stage bevel gear units.

Discussion with experts NORDCON software inclusive

NORDCON software

is the free operating software for control, parameterisation and diagnostics of all NORDAC frequency inverters and motor starters.



Control

A virtual control unit, analogous to a SimpleBox (optional control and parameterisation unit), enables the display of operating values, parameterisation and control of a connected frequency inverter or motor starter.

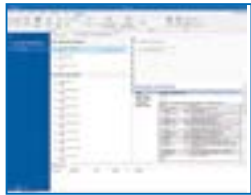

Parameterisation

By means of a convenient overview the user can view and adjust each available parameter. With the corresponding printing option, parameter lists are generated in printed form either completely or only with the values which deviate from the factory settings. The final data sets can be saved on a PC/laptop and archived for future use or sent by e-mail.

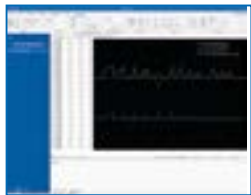

Diagnosis

The NORDCON oscilloscope function is an extremely useful instrument for optimum adjustment of drive systems. By means of line graphs, all drive characteristics (current, torque, etc.) can be recorded and analysed. On the basis of the results, fine tuning of the ideal parameter settings of the relevant drive unit is possible.



PLC programming

A PLC editor is available for creating, editing and managing a PLC program. The PLC programs can also be tested (debugged) with this editor and communicated to the frequency inverter. The programming languages „Structured Text“ and „Instruction List“ according to IEC 61131-3 are supported.

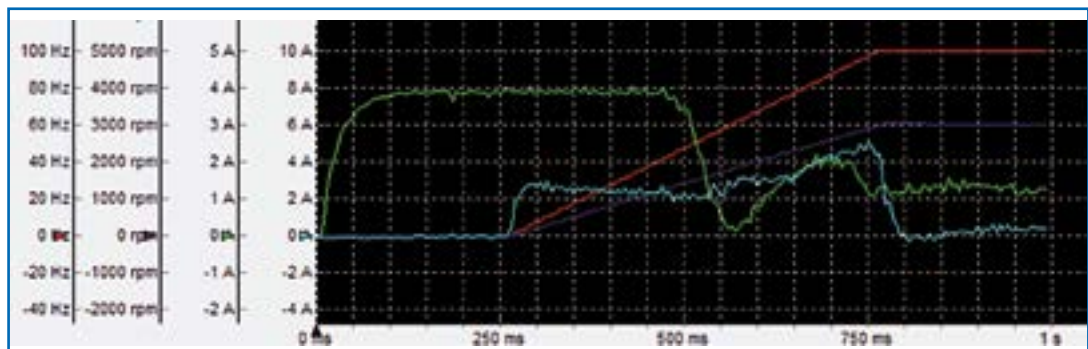

.... and wireless is also possible

NORD opens up a new communication method

With the NORDAC ACCESS BT removable Bluetooth stick you can now make 1:1 connections to your mobile terminal device. Together with the free NORDCON APP, which of course is available for both Android and iOS, you have a practical, smart tool in your pocket, with which you can conveniently access your frequency inverter. The available functions (display operating values, parameterisation and oscilloscope) are familiar from the Windows-based NORDCON software, but are now a little smarter.



Service with the NORDCON APP

The NORDCON APP is a mobile commissioning and service solution with the following advantages for all NORD drives:

- ▶ Dashboard-based visualisation for drive monitoring and fault diagnosis
- ▶ Parameterisation with help function and rapid access to parameters
- ▶ Individually configurable oscilloscope function for drive analysis
- ▶ Backup and recovery function for simple handling of drive parameters



[NORDCON APP](#)

...and why is this now wireless

- ▶ Well, so that you can increase your radius of action when you are working on the device.
- ▶ Because you can communicate with a device inside a safety area without having to enter the danger zone.

For any eventuality Safe stop STO and SS1

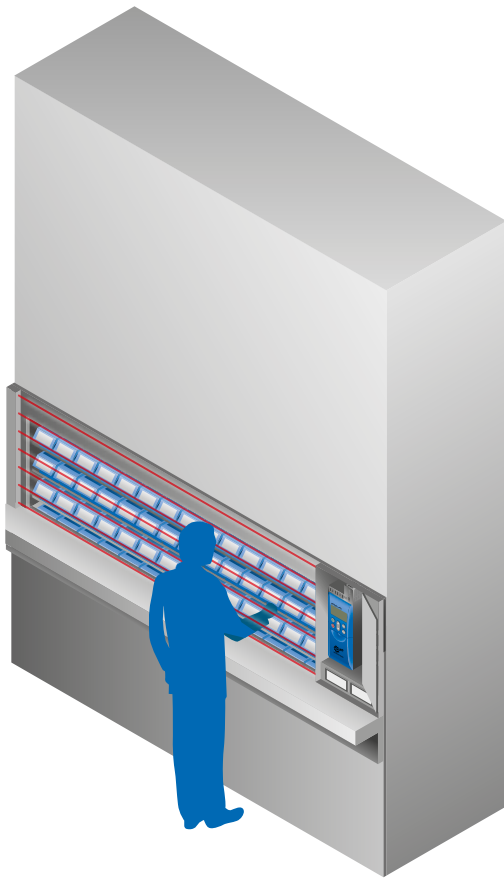

Safe stop

Personnel safety and high machine availability are the focus in system operations. After a safety circuit is actuated by opening a safety cover or door, it must be ensured that no rotating system components can result in accidents.

With a motor controlled by a NORD frequency inverter, this is implemented by a safe pulse block which provides protection against the motor restarting, in compliance with the standard.

This safe block includes the voltage supply to the circuit breaker by means of a safety switching device. The frequency inverter is therefore immediately ready to be switched on without re-initialisation after the safety circuit is closed.

Standards

- ▶ DIN EN ISO 13849-1:
Performance Level e
- ▶ DIN EN 61508: SIL 3
- ▶ DIN EN 60204-1: Stop function
- ▶ DIN EN 61800-5-2:
Safety functions

Applications

- ▶ Rotating machine tools (e.g. milling machines)
- ▶ Closed moving systems with safety doors

Advantages at a glance

- ▶ Certified by TÜV NORD
- ▶ Safe Torque Off (STO)
- ▶ Safe Stop 1 (SS1)
- ▶ High availability through continuous online operation
- ▶ Elimination of contactor components
- ▶ Elimination of initialisation times
- ▶ Long service life due to electronic switching (no electromechanical contacts)
- ▶ Low-cost solution with compact device

Functional safety in bus communication

PROFIsafe (FSoE in preparation)

For drives that have been integrated in system controls via Industrial Ethernet, safe communication can be flexibly transmitted via this already existing Ethernet-based network. The need to hardwire a fail-safe wiring, for an STO function for example, is eliminated.

In this case, drive control information and safety information are transmitted via the same communication system. The decentralised and drive-integrated functional safety for NORD drive systems allows for new safety concepts in different industries: Fail-safe functions in application solutions can be implemented without needing to stop the machine. The optional modules read a fail-safe encoder for the fail-safe monitoring of movements. In combination with a higher-level and fail-safe control, these modules can monitor speed ranges and recognise safe directions of rotation. The NORD solution also provides opportunities to connect functional elements of the functional safety environment such as light-blocking grille or emergency-stop switch to the module, and to transmit the signal states as fail-safe to the control.

Standards

- ▶ DIN EN ISO 13849-1:
Performance Level e
- ▶ DIN EN 61508: SIL 3
- ▶ DIN EN 61800-5-2:
Safety functions
- ▶ DIN EN 61800-3-2

Advantages at a glance

- ▶ Connection and evaluation of a fail-safe SIN /COS encoder possible
- ▶ Support of safety functions SLS, SSR, SDI, SOS, SSM

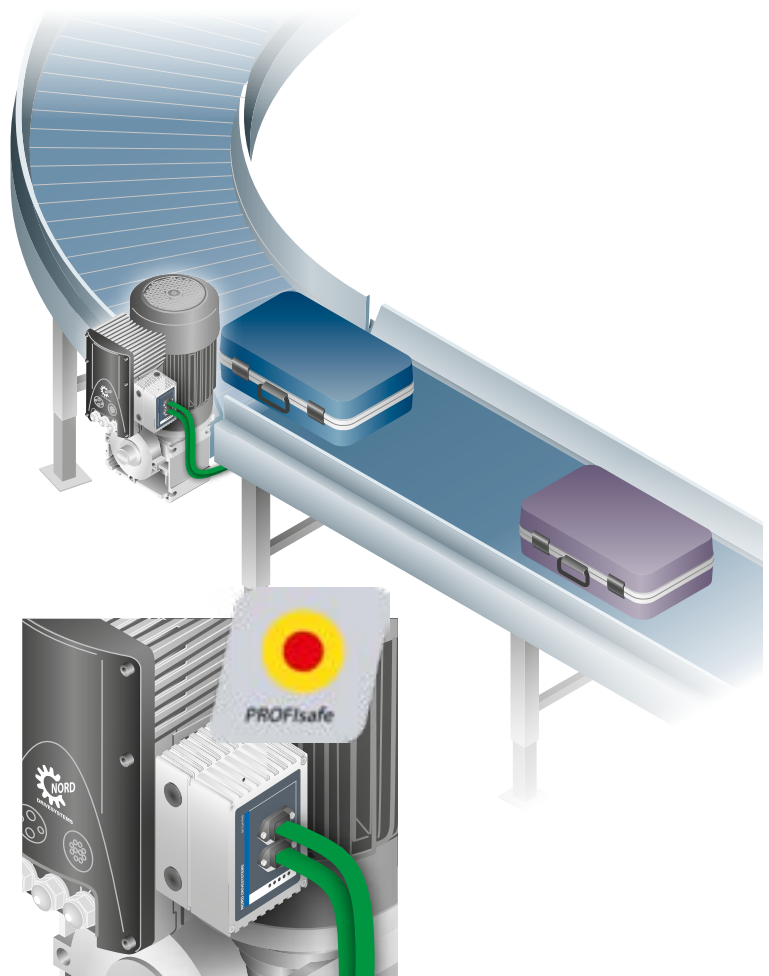

PROFIsafe modules

SK TU4-PNS(-M12)(-C)
Available for NORDAC *FLEX*
(SK 21xE / SK 23xE)

SK CU4-PNS(-C)
Available for NORDAC *LINK*
(SK 260E-FDS / SK 280E-FDS)

Profisafe and FSoE for NORDAC *ON*
in preparation

Encoder

If the main aim of a drive application is maximum accuracy, the integration of an encoder into the drive system is essential. The encoder's task can be principally subdivided into the two categories **speed detection** and **position detection**.

Speed detection for speed control

A frequency inverter with integrated speed control can control the motor speed with utmost accuracy, and directly compensate load changes. This requires the use of an **incremental encoder**. The encoder is directly mounted on the motor shaft and connected to the frequency inverter. The frequency inverter evaluates the speed detected by the encoder and uses it to control the motor speed.

Position detection for position control

Frequency inverters with integrated position control (**POSICON**) allow for the performance of drive applications involving exact positioning without additional components such as photocells, limit switches or the like.

Permanent detection of operating values and intelligent calculation methods of the NORDAC frequency inverter allows for optimum control of the target position at any time, and acceleration values matched to the drive application.

Any common encoder type such as **incremental encoder**, **absolute encoder** or **combination encoder** (absolute encoders with additional incremental track) may be used for position control. Also for this application, the encoder is usually mounted on the motor shaft and connected to the frequency inverter.

Encoder types

Absolute encoder and **combination encoder** register the rotation angle and the number of rotations of the encoder shaft. They code this as a unique position. This position is transmitted to the frequency inverter for direct processing. Absolute and combination encoders “remember” the position and can correctly render it even upon system switch-off and switch-on. Referencing the encoder (adjustment to one reference point) is thus not required or only once during system commissioning.

Incremental encoders, however, only transmit binary pulses to the frequency inverter. These pulses are based on the so-called encoder resolution, that is the number of defined pulses per rotation of the encoder shaft. Here, the frequency inverter determines the position by counting the pulses sent by the encoder. By using two tracks shifted by 90° (¼ pulse width), the frequency inverter identifies the direction of rotation of the drive. As incremental encoders can only submit pulses but no absolute positions, faults on the encoder cables may lead to misinterpretations by the frequency inverter. Encoders with an additional zero track, however, deliver an additional “zero pulse” per full rotation of the encoder shaft. It can be used to compensate minor faults. Switching off the system, however, will lead to the total loss of the position. Positioning tasks with an incremental encoder therefore require additional measures (e.g. regular referencing) and, where necessary, additional components (limit or referencing switches) to ensure permanent and safe positioning operation.

The following table gives an overview of the common encoders approved by NORD. Further information on the encoder types can be found under “Options” in the motor catalogues [M7000](#) (asynchronous motors) or [M5000](#) (synchronous motors). Depending on the type of encoder, they can be combined with certain motors from NORD and NORDAC frequency inverters.



Interface	Encoder		Motors			Frequency inverter					
	Cable length Max. [m]		Asynchronous (ASM), no ATEX	Synchronous (PMSM) IE4	Synchronous (PMSM) IE5+	NORDAC PRO 500E	NORDAC PRO 500P	NORDAC FLEX	NORDAC LINK	NORDAC ON+	NORDAC BASE
HTL	10		IG12 IG22 IG42	IG12 IG22 IG42	IG62	● ¹	● ²	●	●	● ¹	○
MG Contelec	3		MGZ	MGZ	MGZ ¹	○	●	●	●	● ¹	○
TTL	50		IG11 IG21 IG41	IG11 IG21 IG41	IG61P8	● ³	● ³	○	○	○	○
RS485	20		○	○	IG6	○	● ⁵	○	● ⁶	● ⁶	○
SSI	20		AG2	○	○	● ⁴	● ^{1,5}	○	○	●	○
BISS-C	20		○	○	○	● ⁴	● ⁵	○	○	●	○
EnDat 2.1	20		○	○	○	● ⁴	● ⁵	○	○	○	○
HiPERFACE	20		○	○	○	● ⁴	● ⁵	○	○	○	○
CANopen	20		AG1 ⁷	AG1 ⁷	○	●	●	○	○	○	○
			AG4 ⁸	AG4 ⁸	○	○	● ²	●	●	○	○
			AG7 ¹	AG7 ¹	○	●	●	●	●	○	○
			AG8 ⁷	AG8 ⁷	○	●	●	○	○	○	○
			AG9 ⁸	AG9 ⁸	○	○	● ²	●	●	○	○

● Available
○ Not available

IG = Incremental encoder
AG = Absolute/combo encoder
MGZ = Incremental encoder with zero track

¹ Positioning only, no closed-loop operation
² No PMSM closed-loop operation
³ SK 520E or SK 530P and higher
⁴ SK 540E and higher
⁵ SK 530P and higher, firmware version 1.4 and higher, and only in combination with the optional SK CU5-MLT customer unit
⁶ Standard version for IE5+
⁷ Combo encoder, AG with TTL track
⁸ Combo encoder, AG with HTL track

When extreme precision is REQUIRED POSICON and PLC



POSICON

Frequency inverters with integrated POSICON functionality are able to determine the actual position of the drive unit via appropriate interfaces. Incremental encoder inputs (TTL/HTL) or connections for absolute encoders are available as interfaces via CANopen® (NORDAC PRO from SK 540E and above and SK 530P and above. Sine wave encoders, SSI, BiSS-C, EnDat 2.1 and HIPERFACE are also available. In addition to conventional point-to-point positioning (absolute positioning), POSICON also provides the facility for relative positioning of endless axes as well as various technology functions (rotating platform „with travel optimisation“, synchronous operation and flying saw).

By means of the standard POSICON position memory and features such as „teach in“, „approach reference point“, „reset position“, „offset position“, „target window positioning“ and „S-ramp“, the frequency inverter can carry out fully independent positioning control. The tasks for the external control system are therefore reduced to the starting pulse and communication of the target position (via digital I/O or at the field bus level). The frequency inverter can even monitor the positioning process and report the operating status.

Applications

- ▶ Lifting gear/shelf storage and retrieval devices with approach to precise positions
- ▶ Running gear of material conveyors / portal cranes with synchronous function of all driven axes
- ▶ Rotating table functions for tool magazines on machines
- ▶ Flying saw: coupling and parallel movement of a positioning axis relative to a moving object

PLC

The intelligent drive electronics with integrated PLC functionality reduces the load on the higher level system control unit. This enables a modular system design. Application data can be evaluated in real time by the decentralised PLC, for example for the optimisation of diagnostic facilities. The PLC functionality enables the application to respond according to the situation.

- ▶ The PLC can be programmed with the NORDCON software (IEC 61131-3, Structured Text ST and Instruction List IL).
There are no license fees or other runtime costs.
- ▶ Customer-specific control functions can be simply integrated with the PLC. Evaluation of sensor data and control of actuators replaces the machine control or drive control.
- ▶ Motion Control function blocks for implementation of movement control based on the PLCopen standard are available.

Applications

- ▶ Regulation/control of one or more devices by the frequency inverter

Contents

NORDAC *PRO*, SK 500P series
frequency inverters up to 22.0 kW
up to 160 kW, in preparation
for control cabinet applications

Page 29



NORDAC *PRO*, SK 500E series
frequency inverters up to 160 kW
for control cabinet applications

Page 55



NORDAC *LINK*, SK 250E-FDS series
NORDAC *LINK*, SK 155E-FDS series
field distributors as frequency inverters up to 7.5 kW,
field distributors as motor starters up to 3.0 kW
for decentralised applications

Page 79



NORDAC *ON*, SK 300P series
frequency inverters up to 3.7 kW
for decentralised applications

Page 97



NORDAC *FLEX*, SK 200E series
frequency inverters up to 22.0 kW
for decentralised applications

Page 111



NORDAC *BASE*, SK 180E series
frequency inverters up to 2.2 kW
for decentralised applications

Page 137



NORDAC *START*, SK 135E series
Motor starters up to 7.5 kW
for decentralised applications

Page 153



Accessories
for NORDAC *ON*, *LINK*, *FLEX*, *BASE* and *START*

Page 169





Frequency inverter for control cabinet application

NORDAC *PRO* SK 500P series

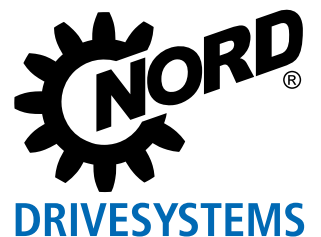

Top class inverter technology

NORDAC *PRO*, SK 500P series



[NORDAC *PRO* - SK 500P](#)

NORDAC *PRO* SK 500P frequency inverters are available for motors with rated powers from 0.25 to 22.0 kW (up to 160 kW, in preparation)(15/18.5/22 kW [available for SK 530P and higher](#)). With their very compact design, the so-called book size format, they are perfect for space-saving installation in control cabinets.

Notable features across the entire product line include:

- ▶ Sensorless current vector control which ensures constant speeds in case of fluctuating loads and very high torques during start-up
- ▶ 200% overload reserve which provides greater operational safety in cranes and lifting gear applications
- ▶ Operation of asynchronous and synchronous motors
- ▶ Integrated brake chopper for 4-quadrant operation
- ▶ Integrated line filter as the basis for optimal EMC performance
- ▶ Integrated PLC, which enables convenient free programming of drive-related functions according to IEC 61131-3.

These features are as much a part of the basic configuration as the separately configurable PID or the process controller.

Functional safety is increasingly becoming the focus of attention in drive technology. To meet the various safety requirements, the NORDAC *PRO* also offers functional extensions to implement single or dual channel solutions for Safe Torque Switch-off and Safe Stop.

An optional removable operating display provides an extensive selection of operational displays and status information. Naturally, it also allows direct access to parameterisation.

As standard, the frequency inverters are equipped with an integrated mains unit to supply the control board. The [USB port](#), which is provided as standard for configuration version SK 530P and higher, also provides the facility of accessing the frequency inverter control board without connection of the mains voltage.

Devices with configuration level SK 530P and higher are equipped with a separate 24 V DC connection. These devices can also be parameterised when the power is switched off. Restricted diagnosis and communication with the bus is also retained.

Optional SK CU5 extensions, which can be combined with all SK 530P or SK 550P devices, complete the range of functions.

These include the encoder extension or the universal encoder interface for connection of a wide range of encoders (e.g. SSI, EnDat 2.1), which in combination with the installed POSICON are the ideal solution for all types of positioning (relative and absolute). Only one SK CU5 extension can be connected between the frequency inverter and the operating display.

An Ethernet interface is integrated in configuration levels SK 550P and above. During commissioning this can be simply set by switching a parameter to the required dialect (Ethernet/IP®, EtherCAT®, PROFINET IO® or POWERLINK). The great flexibility for system planning is enhanced by the comparatively small variance in hardware



Introduction
NORDAC PRO SK 500P
NORDAC PRO SK 500E
NORDAC LINK
NORDAC ON
NORDAC FLEX
NORDAC BASE
NORDAC START
Accessories

Basic configuration

- Sensorless current vector control (ISD control) for high precision control and fast response times
- Brake management, electromechanical holding brake
- Brake chopper to divert generated energy to a brake resistor
- CANopen® including drive profile DS402
- POSICON variants with positioning function (relative and absolute)
- RS-485/RS-232 diagnostic interface
- 4 switchable parameter sets for flexible use of parameter settings (e.g. switching between drive units with different motor data)
- All common drive functions such as acceleration/braking on a ramp, S curves
- Parameters pre-set with standard values, hence immediately ready for use
- Scalable display values
- Stator resistance measurement to ensure optimal control characteristics
- Integrated PLC functionality
- Plug-in connection terminals
Available for all devices up to 2.2 kW



Optional

- Interfaces for many Industrial Ethernet-based bus systems
- Removable operating display with extensive operating and status indicators. Parameter editing facility.
- Variants for implementation of safe drive functions (e.g. STO, SS1-t)
- Interface extensions for connection of encoders and IOs
- USB-C interface for parameterisation via PC using the NORDCON software, without additional connection of a mains or control voltage.



NORD provides the new SK 500P with features for easier working:

Electrical connection Power terminals

In addition to the control terminals on the front (which are always pluggable), for the two small sizes of frequency inverters with rated powers up to 2.2 kW, all other power terminals (e.g. line and motor connections, connections to multi-function relays, etc.) can be removed for maintenance. In this way, wiring of the very compact devices can be carried out easily and safely even in confined control cabinet spaces.

The architecture of Size 3 (frequency inverters with rated powers of 3.0 kW and above) allows so much space that a plug-in design of the power terminals would not provide any further advantage.



Control terminals

Pluggable control terminals are nothing special. However, the fact that the NORDAC PRO is equipped with an integrated „3rd hand“ which simply fixes the spring terminals for wiring will probably be gladly welcomed by most technicians.



Parameter setup

... do you want to view operating values or error messages or access and modify frequency inverter parameter settings?

Use the method that suits you:

- ▶ Direct access with the snap-on SK TU5-CTR technology unit or SK TU5-PAR (optional)
- ▶ Separate SK PAR-5H or SK CSX-3E (optional) control and parameterisation units which can be mounted in the control cabinet doors
- ▶ NORDCON software (free) – by connecting a Windows computer via USB-C ¹ or RJ12
- ▶ NORDCON APP (free) for connection to a mobile terminal device via NORDCON ACCESS BT (optional)
- ▶ Removable data carrier (microSD) for backup and transfer of parameter data sets (optional)







Available for SK 530P and higher

¹ No additional connection of a mains or control voltage required, USB-Cable “SK CE-USB-C-PC-USB-3M” required.



Standards and approvals

All devices of the entire series comply with the standards and directives listed below.

Approval	Directive	Applied standards	Certificates	Code
CE (European Union)	Low Voltage Directive 2014/35/EU	EN 61800-5-1 EN 60529	C310601	
	EMC 2014/30/EU	EN 61800-3 EN 63000		
	RoHS 2011/65/EU	EN 61800-9-1 EN 61800-9-2		
	Delegated directive (EU) 2015/863			
	Ecodesign 2009/125/EG			
	Regulation (EU) Ecodesign 2019/1781			
UL (USA)		UL 61800-5-1	E171342 ¹	
CSA (Canada)		C22.2 No.274-13	E171342 ¹	
RCM (Australia)	F2018L00028	EN 61800-3		
EAC (Eurasia)	TR CU 004/2011, TR CU 020/2011	IEC 61800-5-1 IEC 61800-3	EA3C N RU Д- DE.HB27.B02718/20	
UkrSEPRO (Ukraine)	F2018L00028	EN 61800-5-1 EN 60529 EN 61800-3 EN 63000 EN 60947-1 EN 60947-4 EN 61558-1 EN 50581	C311900	
UKCA (United Kingdom)		EN 61800-5-1 EN 60529 EN 61800-3 EN 63000 EN 61800-9-1 EN 61800-9-2	C350601	

¹ UL/CSA: up to and including 110 kW only, > 110 kW on request

Introduction
NORDAC PRO SK 500P
NORDAC PRO SK 500E
NORDAC LINK
NORDAC ON
NORDAC FLEX
NORDAC BASE
NORDAC START
Accessories

Type code

Frequency inverters

SK 530P-370-340-A

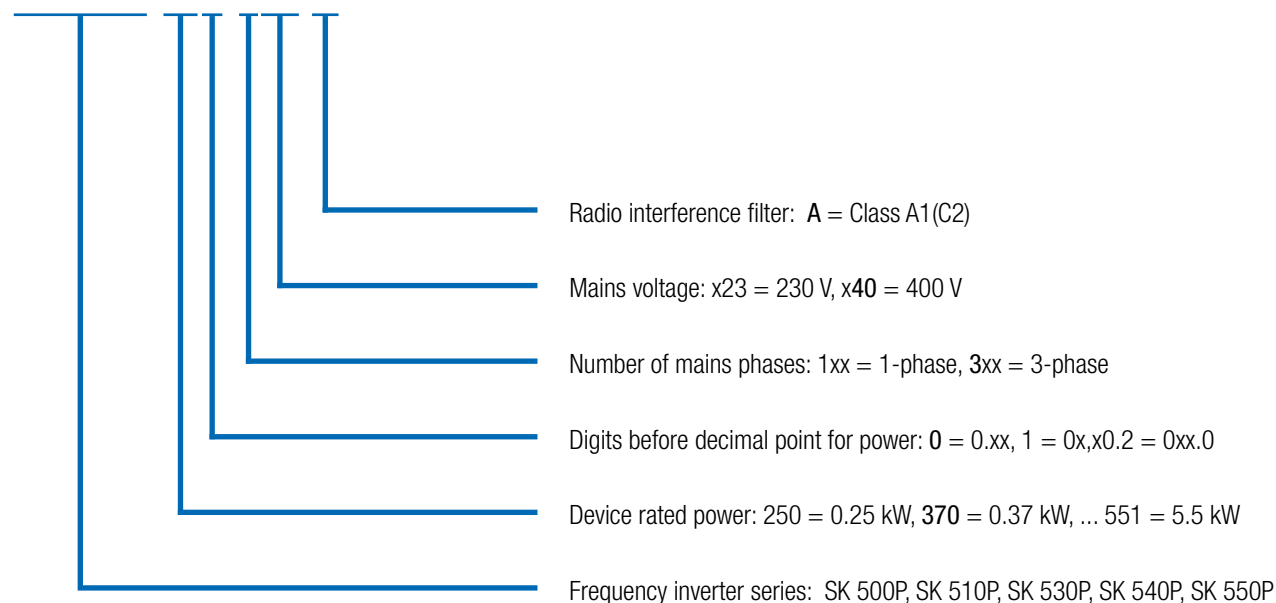

Technology units

SK TU5-CTR

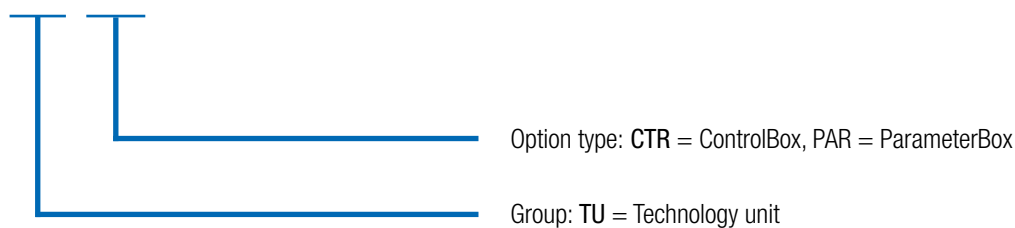

Customer units

SK CU5-STO

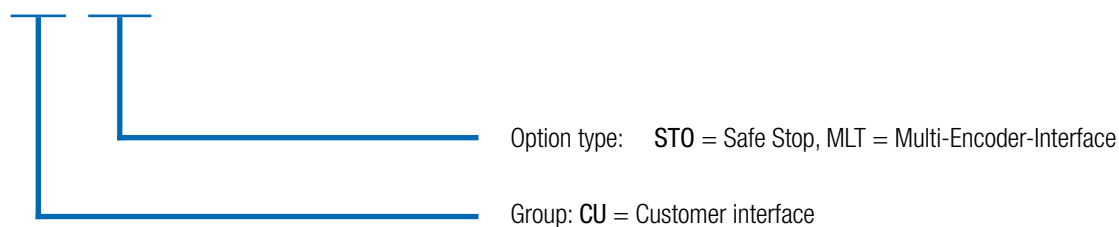

NORDAC PRO

All versions at a glance

	Basic Drive SK 500P SK 510P	Advanced Drive SK 530P SK 540P SK 550P
	Size 1-4	Size 1-5
Sensorless current vector control (ISD control)	●	●
Asynchronous motor operation (closed-loop and open-loop)	●	●
Synchronous motor operation (PMSM) (closed-loop and control without encoder)	●	●
Brake management for mechanical holding brake	●	●
Brake chopper (brake resistor optional)	●	●
RS-232 diagnostic interface	●	●
4 switchable parameter sets	●	●
All normal drive functions	●	●
Parameters pre-set with standard values	●	●
Stator resistance measurement	●	●
Energy-saving function, optimised efficiency in partial load operation	●	●
Integrated EMC line filter according to EN 61800-3, Category C2 up to 20 m motor cable, Category C1 up to 5 m motor cable (devices above 0.75 kW)	●	●
Shielding plate for connection of shielded control cables for EMC-compliant wiring.	●	●
Extensive monitoring functions	●	●
Load monitor	●	●
Link circuit coupling	●	●
Lifting gear functionality	●	●
PID controller	●	●
Process controller / compensator control	●	●
Incremental encoder input (HTL / TTL) for speed feedback - servo mode	● ¹	●
POSICON	●	●
PLC functionality	●	●
USS, Modbus RTU (RJ12)	●	●
CANopen® (connection terminals)	●	●
PROFINET IO® (default), EtherCAT®, Ethernet IP®, POWERLINK	○	● ²
"Safe Torque Switch-off" and "Safe Stop" (STO, SS1) functions	● ³	● ⁴
USB port (Parameterisation of the FI by means of NORDCON without mains or control voltage connection)	○	●
Internal 24 V power supply unit to supply the control board	●	●
External 24 V DC supply for the control board voltage supply with automatic switch-over between the internal and external 24 V DC control voltage	○	●
Universal encoder interface	○	●
MicroSD slot, port for removable data carrier	○	●
Removable data carrier (microSD) for backup and transfer of parameter data sets	○	●
Operating display, removable for display of status and operating information and for control	●	●
Communication interface, removable, for wireless communication between the frequency inverter and mobile terminal devices (tablet, smartphone)	●	●

¹ HTL only

² SK 550P only

³ SK 510P only, Single channel

⁴ SK 540P as standard, single-channel

⁵ not SK 540P

● Available as standard

● Optional

○ Not available

	Basic Drive SK 500P SK 510P	Advanced Drive SK 530P SK 540P SK 550P		
	Size 1-4	Size 1-5		
Control terminals	DIN	6 ¹		
	DOUT	2		
	Signal relay ² (... 230 V AC, 2 A)	2		
	AIN ³	2		
	AOUT ³	1		
	Temperature sensor (PTC)	1 ⁴		
	TTL RS422	○	●	
Encoder interfaces	RS485	○	● ⁵	
	HTL ⁴	●	●	
	CANopen [®]	●	●	
	SIN / COS	○	● ⁵	
	SSI	○	● ⁵	
	BISS-C	○	● ⁵	
	HIPERFACE	○	● ⁵	
	EnDat 2.1	○	● ⁵	
	Communication	CAN / CANopen [®]	● ⁶	●
		RS485 / RS232	●	●
Modbus RTU		●	●	

¹ Extendable with the optional SK CU5-... customer interface

² Parameterisable with DOUT functions

³ AIN/AOUT can also be used for digital signals.

AIN: 0(2) – 10 V, 0(4) – 20 mA,

AOUT: 0 – 10 V, 0 – 20 mA

⁴ Function can only be implemented through a digital input, permissible length of encoder cables: max. 10 m

⁵ Available via optional customer unit, not SK 540P

⁶ System bus functions can only be used with restrictions.



Temperature sensor (PTC)
SK 530P
and above

TTL encoder interface
SK 530P
and above

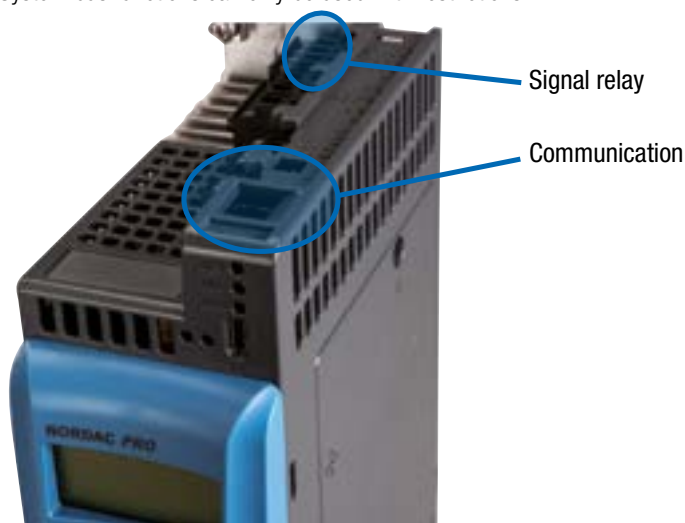

Signal relay

Communication

Control terminals AIN/
AIN / DIN

zAdditional
control terminals
DIN / DOUT

SK 530P and above

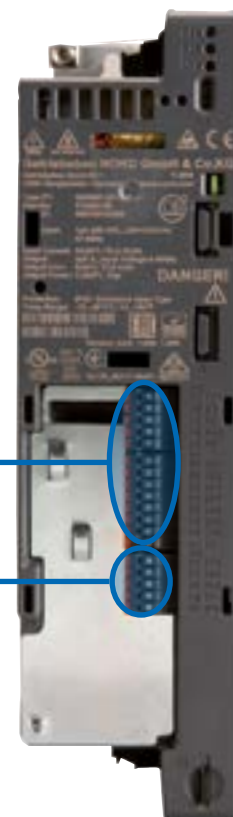

Optional modules for function extension

Frequency inverters with configuration variants SK 530P and SK 550P can be extended with a plug-in optional module. This increases the installation depth by 23 mm.

One of the following variants can be selected.

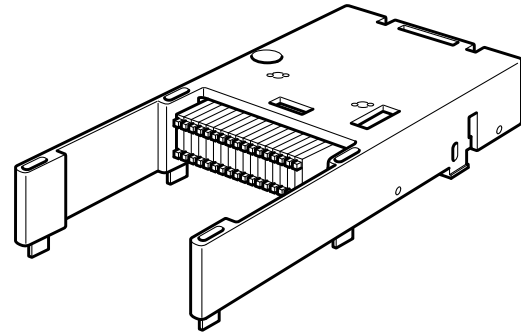

Type	Material No.	Functions	I/Os	Remarks
SK CU5-MLT	275 298 200	Encoder interface: TTL, SIN/COS, HIPERFACE, EnDat 2.1, BiSS-C, SSI Functional safety: STO - PLe / SIL 3 SS1-t - PLd / SIL 2	4 IO (usable as DIN or DOUT) 1 Safe DIN	Functional safety: 2-channel connection
SK CU5-STO	275 298 000	Functional safety: STO - PLe / SIL 3 SS1-t - PLd / SIL 2	1 Safe DIN	Functional safety: 2-channel connection



NORDAC *PRO* SK 500P frequency inverter

1~ 200 ... 240 V,

Output frequency	0.0 ... 400.0 Hz	Protection class	IP20
Pulse frequency	3.0 ... 16.0 kHz	Regulation and control	Sensorless current vector control (ISD), linear V/f characteristic curve
Typical overload capacity	150 % for 60 s, 200 % for 3.5 s	Motor temperature monitoring	I ² t Motor PTC / bi-metal switch
Energy efficiency class	IE2	Leakage current	<30 mA, may be considerably less depending on the size and configuration of the frequency inverter (refer to the manual for details)
Efficiency	Size 1-3 approx. 95 % Size 4-6 approx. 97% Size 7-10 approx. 98 %		
Ambient temperature	-10 °C ... +40 °C (S1) -10 °C ... +50 °C (S3, 70 % ED)		

Frequency inverters SK 5xxP ...	Nominal motor power		Nominal output current rms [A]	Mains voltage	Output voltage
	230 V [kW]	240 V [hp]			
-250-123-A	0.25	1/3	1.7	1~ 200 ... 240 V, +/- 10 %, 47 ... 63 Hz	3~ 0 up to mains voltage
-370-123-A	0.37	1/2	2.4		
-550-123-A	0.55	3/4	3.2		
-750-123-A	0.75	1	4.2		
-111-123-A	1.1	1 1/2	5.7		
-151-123-A	1.5	2	7.3		
-221-123-A	2.2	3	9.6		

Size 1 and 2

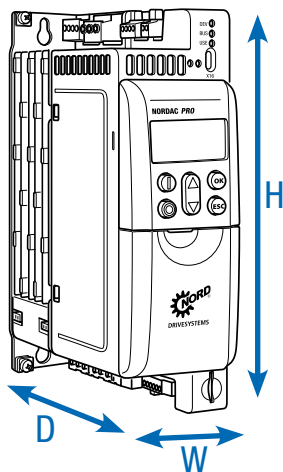

Size 3 -11

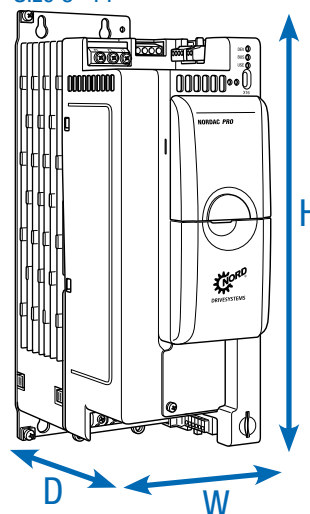

Frequency inverters SK 5xxP ...	Weight [kg]	(Overall) dimensions H x W x D [mm]	Size
-250-123-A	1.2	200 x 66 x 141	1
-370-123-A	1.2	200 x 66 x 141	1
-550-123-A	1.2	200 x 66 x 141	1
-750-123-A	1.2	200 x 66 x 141	1
-111-123-A	1.6	240 ¹ x 66 x 141	2
-151-123-A	1.6	240 ¹ x 66 x 141	2
-221-123-A	1.6	240 ¹ x 66 x 141	2

¹ SK 5xxP-221-123: Connection terminal protrudes beyond the stated overall dimension H about 15 mm.

NORDAC PRO SK 500P frequency inverter

3~ 380 ... 480 V

Output frequency	0.0 ... 400.0 Hz	Protection class	IP20
Pulse frequency	3.0 ... 16.0 kHz	Regulation and control	Sensorless current vector control (ISD), linear V/f characteristic curve
Typical overload capacity	150 % for 60 s, 200 % for 3.5 s	Motor temperature monitoring	I ² t Motor PTC / bi-metal switch
Energy efficiency class	IE2	Leakage current	<30 mA, may be considerably less depending on the size and configuration of the frequency inverter (refer to the manual for details)
Efficiency	Size 1-3 approx. 95 % Size 4-6 approx. 97% Size 7-10 approx. 98 %		
Ambient temperature	-10 °C ... +40 °C (S1) -10 °C ... +50 °C (S3, 70 % ED)		

Frequency inverters SK 5xxP ...	Nominal motor power		Nominal output current rms [A]	Mains voltage	Output voltage
	400 V [kW]	480 V [hp]			
-250-340-A	0.25	1/3	1.0	3~ 380 ... 480 V, -20 % / +10 %, 47 ... 63 Hz	3~ 0 up to mains voltage
-370-340-A	0.37	1/2	1.3		
-550-340-A	0.55	3/4	1.8		
-750-340-A	0.75	1	2.4		
-111-340-A	1.1	1 1/2	3.1		
-151-340-A	1.5	2	4.0		
-221-340-A	2.2	3	5.6		
-301-340-A	3.0	4	7.5		
-401-340-A	4.0	5	9.5		
-551-340-A	5.5	7 1/2	12.5		
-751-340-A	7.5	10	16.0		
-112-340-A	11.0	15	24.0		
-152-340-A	15.0	20	31.0		
-182-340-A	18.5	25	38.0		
-222-340-A	22.0	30	46.0		
-302-340-A	30.0	40	60.0		
-372-340-A	37.0	50	75.0		
-452-340-A ¹	45.0	60	90.0		
-552-340-A ¹	55.0	75	110.0		
-752-340-A ¹	75.0	100	150.0		
-902-340-A ¹	90.0	125	180.0		
-113-340-A ¹	110	150	220.0		
-133-340-A ¹	132	180	260.0		
-163-340-A ¹	160	220	320.0		

¹ Power range extension up to 160 kW in the third quarter of 2025 in preparation

Size 1 and 2

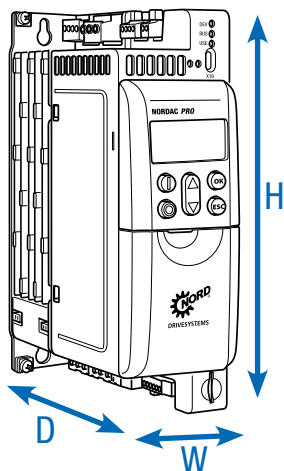

Size 3 -11

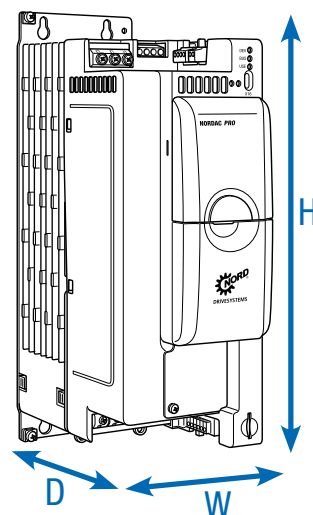





Frequency inverters SK 5xxP ...	Weight [kg]	(Overall) dimensions H x W x D [mm]	Size
-250-340-A	1.2	200 x 66 x 141	1
-370-340-A	1.2	200 x 66 x 141	1
-550-340-A	1.2	200 x 66 x 141	1
-750-340-A	1.2	200 x 66 x 141	1
-111-340-A	1.6	240 x 66 x 141	2
-151-340-A	1.6	240 x 66 x 141	2
-221-340-A	1.6	240 x 66 x 141	2
-301-340-A	2.6	286 x 91 x 175	3
-401-340-A	2.6	286 x 91 x 175	3
-551-340-A	2.6	286 x 91 x 175	3
-751-340-A	3.8	331 x 91 x 175	4
-112-340-A	3.8	331 x 91 x 175	4
-152-340-A	7.1	371 x 126 x 232	5
-182-340-A	7.1	371 x 126 x 232	5
-222-340-A	7.1	371 x 126 x 232	5
-302-340-A	15.0	495 x 185 x 246	6
-372-340-A	15.0	495 x 185 x 246	6
-452-340-A ¹	20.0	598 x 265 x 286	7
-552-340-A ¹	20.0	598 x 265 x 286	7
-752-340-A ¹	25.0	636 x 265 x 286	8
-902-340-A ¹	25.0	636 x 265 x 286	8
-113-340-A ¹	46.0	720 x 395 x 292	9
-133-340-A ¹	49.0	720 x 395 x 292	9
-163-340-A ¹	52.0	799 x 395 x 292	10

¹ Power range extension up to 160 kW in the third quarter of 2025 in preparation



Interfaces for operation, parameterisation and communication

Operation and parameterisation

Optional modules with up to 14 languages for displaying status and operational indicators, parameterisation and operation of the frequency inverter. In addition to variants for direct mounting on the device or installation in a control cabinet door, hand held versions are also available. See also Accessories starting on page 165

Type	Description	Description	Remarks
ControlBox SK TU5-CTR 275 297 000		Suitable for operation and parameterisation, LCD screen (illuminated), 5-digit, 7-segment display, display of measurement unit, various status and operating displays, display of utilisation level, convenient keypad.	Installation in the SK TU5 slot on the device.
ParameterBox SK TU5-PAR 275297100		Suitable for control and parameterisation, LCD screen (illuminated), plain text display in 14 languages, memory for 5 device data sets, convenient control keypad	Installation in the SK TU5 slot on the device. Required firmware version of the frequency inverter: V1.4 R0 and higher
ParameterBox SK PAR-5H 275 281 614		Control and parameterisation, LCD (illuminated), plain text display in 14 languages, direct control of up to five devices, memory for five device data sets, convenient control keypad, communication via RS485, including 1.5 m connection cable. Handheld, suitable for installation in a control cabinet door. IP54	Connection for data exchange with NORDCON <i>STUDIO</i> to a PC (USB 2.0), (standard "USB-C" connection cable required, e.g. material number: 275 292 100) Power supply, e.g. directly via frequency inverter or PC
SimpleControlBox SK CSX-3E 275 281 413		Suitable for control and parameterisation, 4-digit, 7-segment display, direct control of a device, convenient control keypad, for installation in control cabinet doors.	Electrical data: 4.5 ... 30 V DC / 1.3 W, Supply e. g. directly via the frequency inverter. Control cabinet installation

Introduction
NORDAC PRO SK 500P
NORDAC PRO SK 500E
NORDAC LINK
NORDAC ON
NORDAC FLEX
NORDAC BASE
NORDAC START
Accessories

Type Designation Material No.	Description	Remarks
	<p>Control and parameterisation software NORDCON</p>	<p>Software for control and parameterisation as well as support for commissioning and fault analysis of NORD electronic drive technology. Parameter names in 14 languages</p>
<p>Free download: www.nord.com</p>		
	<p>Bluetooth stick NORDAC <i>ACCESS BT</i> SK TIE5-BT-STICK 275 900 120</p>	<p>Interface for wireless connection to a mobile terminal device (e.g. tablet or smartphone) via Bluetooth. With the aid of the NORDCON <i>APP</i>, the NORDCON software for mobile terminal devices, enables smart operation and parameterisation as well as commissioning assistance and fault analysis of NORD electronic drive technology.</p>
		<p>Available free of charge for Android and iOS</p>
		

Line filter

Improvement of EMC

General

Line filters are used to reduce the emission of electromagnetic interference. SK 500P frequency inverters are equipped with an integrated class C2 line filter, class C3 line filter for 30 kW and higher, (max. 20 m of shielded motor cable). For devices with nominal powers from 750 W to 5.5 kW, class C1 (max. 5 m of shielded motor cable) is achieved. Various adaptive line filters are available for longer cable lengths or to improve interference suppression.

Chassis line filter, SK HLD

The line filter meets protection class IP20 and enables interference suppression Class C1 with max. 25 m shielded motor cable and Class C2 with max. 50 m cable.

The line filters are installed separately from the frequency inverter.

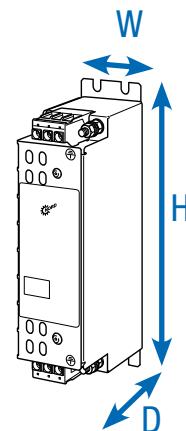

	Frequency inverters SK 5xxP ...	Line filter type Material No.	Continuous current [A]	Leakage current ¹ [mA]	(Overall) dimensions H x W x D [mm]
3~400 V	0.55 ... 2.2 kW	SK HLD 110-500/8 278 272 008	8.0	20 / 190	190 x 45 x 75
	3.0 ... 5.5 kW	SK HLD 110-500/16 278 272 016	16.0	21 / 205	250 x 45 x 75
	7.5 kW	SK HLD 110-500/30 278 272 030	30.0	29 / 280	270 x 55 x 95
	11.0 kW	SK HLD 110-500/42 278 272 042	42.0	30 / 290	310 x 55 x 95
	15.0 ... 18.5 kW	SK HLD 110-500/55 278 272 055	55.0	30 / 290	255 x 85 x 95
	22.0 kW	SK HLD 110-500/75 278 272 075	75.0	22 / 210	310 x 85 x 135

¹ Leakage current 1st value: rated for the maximum permissible input voltage fluctuation according to IEC 38 + 10%

Leakage current 2nd value: calculated at maximum input voltage and failure of 2 phases (typically at 50 Hz)

Mains chokes

Reduction of mains feedback

General

It may be necessary for some drive systems to use mains chokes to reduce dangerous mains current peaks. With their use, external mains feedback effects are considerably reduced and the proportion of current harmonics is reduced to a minimum. The input current is reduced to approximately the value of the output current.

It is recommended that a mains choke be used at all times for a frequency inverter capacity of 45 kW and above. This will have an additional positive effect on device protection and EMC characteristics. All chokes have protection class IP00 and are UL-recognised.

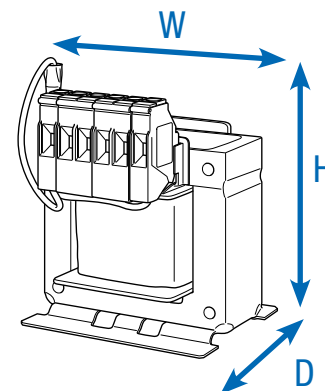

	Frequency inverters SK 5xxP ...	Choke type Material No.	Continuous current [A]	Inductance [mH]	(Overall) dimensions H x W x D [mm]
1~230 V	0.25 ... 0.37 kW	SK CI5-230/006-C 276 993 005	6.0	4.88	70 x 66 x 60
	0.55 ... 0.75 kW	SK CI5-230/010-C 276 993 009	10.0	2.93	95 x 78 x 84
	1.1 ... 2.2 kW	SK CI5-230/025-C 276 993 024	25.0	1.17	98 x 87 x 84
3~400 V	0.25 ... 0.75 kW	SK CI5-500/004-C 276 993 004	4.0	3 x 7.35	117 x 80 x 60
	1.1 ... 2.2 kW	SK CI5-500/008-C 276 993 008	8.0	3 x 3.68	140 x 120 x 85
	3.0 ... 5.5 kW	SK CI5-500/016-C 276 993 016	16.0	3 x 1.84	140 x 120 x 95
	7.5 ... 11.0 kW	SK CI5-500/035-C 276 993 035	35.0	3 x 0.84	167 x 155 x 110
	15.0 ... 22.0 kW	SK CI5-500/063-C 276 993 063	63.0	3 x 0.47	206 x 185 x 122
	30.0 ... 37.0 kW	SK CI5-500/100-C 276 993 101	100.0	3 x 0.30	205 x 267 x 155
	45.0 kW	SK CI1-480/100-C 276 993 100	100.0	3 x 0.29	263 x 240 x 148
	55.0 ... 75.0 kW	SK CI1-480/160-C 276 993 160	160.0	3 x 0.18	268 x 352 x 140
	90.0 kW	SK CI1-480/280-C 276 993 280	280.0	3 x 0.10	268 x 352 x 169
	110.0 ... 132.0 kW	SK CI1-480/350-C 276 993 350	350.0	3 x 0.08	268 x 352 x 169
	160 kW	nicht verfügbar			

Link circuit choke

Reduction of mains feedback

Link circuit choke SK DCL

Similar to a mains choke, reduces the network loads of a frequency inverter that are inherent to its functional principle. It is connected to easily accessible contacts in the frequency inverter's intermediate circuit and is available for 45 kW and above. All chokes have protection class IP00 and are UL-recognised.

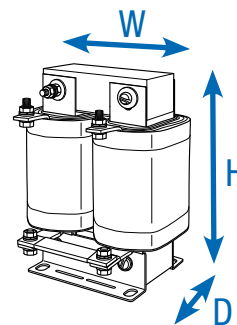

Frequency inverter SK 5xxP ...	Choke type Material No.	Continuous current [A]	Inductance [mH]	(Overall) dimensions H x W x D [mm]
45.0 ... 55.0 kW	SK DCL-950/120-C 276 997 120	120.0	0.50	230 x 148 x 147
75.0 ... 90.0 kW	SK DCL-950/200-C 276 997 200	200.0	0.30	260 x 170 x 153
110 kW	SK DCL-950/260-C 276 997 260	260.0	0.25	284 x 180 x 174
132 kW	SK DCL-950/320-C 276 997 320	320.0	0.20	282 x 180 x 189
160 kW	SK DCL-950/380-C 276 997 380	200.0	0.17	282 x 180 x 189

Motor chokes

Compensation of cable capacitances

General

Long motor cable lengths (cable capacity) often require the use of additional motor chokes on the frequency inverter output. In addition, the use of motor chokes has a positive effect on device protection and EMC characteristics.

The specified motor chokes are rated for a pulse frequency of 3 to 6 kHz and an output frequency of 0 to 120 Hz. All chokes have protection class IP20 and are UL-recognised.

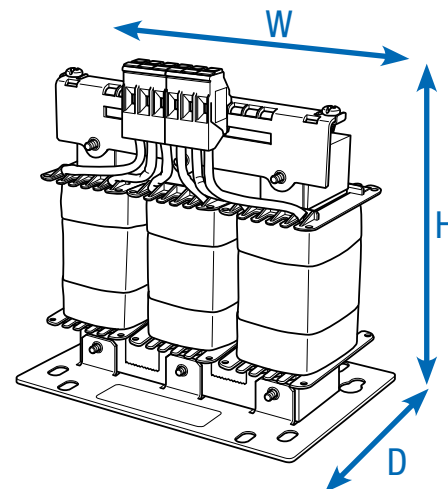

	Frequency inverters SK 5xxP ...	Choke type Material No.	Continuous current [A]	Inductance [mH]	(Overall) dimensions H x W x D [mm]
1~230V	0.25 ... 0.37 kW	SK C05-500/002-C 276 992 002	2.5	3 x 3.68	140 x 120 x 85
	0.55 ... 0.75 kW	SK C05-500/006-C 276 992 006	6.0	3 x 1.54	140 x 120 x 95
	1.1 ... 2.2 kW	SK C05-500/012-C 276 992 012	12.5	3 x 0.74	165 x 155 x 95
3~400V	0.25 ... 0.75 kW	SK C05-500/002-C 276 992 002	2.5	3 x 3.68	140 x 120 x 85
	1.1 ... 2.2 kW	SK C05-500/006-C 276 992 006	6.0	3 x 1.54	140 x 120 x 95
	3.0 ... 5.5 kW	SK C05-500/012-C 276 992 012	12.5	3 x 0.74	165 x 155 x 95
	7.5 ... 11 kW	SK C05-500/024-C 276 992 024	24.0	3 x 0.38	192 x 185 x 112
	15.0 ... 22.0 kW	SK C05-500/046-C 276 992 046	46.0	3 x 0.20	239 x 210 x 125
	30.0 ... 37.0 kW	SK C05-500/75-C 276 992 075	75.0	3 x 0.122	260 x 230 x 149
	45.0 kW	SK C01-460/90-C 276 996 090	90.0	3 x 0.22	352 x 144 x 325
	55.0 ... 75.0 kW	SK C01-460/170-C 276 996 170	170.0	3 x 0.13	320 x 412 x 200
	90.0 ... 110 kW	SK C01-460/240-C 276 996 240	240.0	3 x 0.07	320 x 412 x 225
	132.0 ... 160 kW	SK C01-460/330-C 276 996 330	330.0	3 x 0.03	268 x 352 x 188

Braking resistors for dynamic drive characteristics

Bottom-mounted braking resistors SK BRU5

These are available four sizes. The brake resistor can be mounted flat underneath the frequency inverter. Although this increases the installation length and depth by a few centimetres, the basic installation surface in the control cabinet is considerably reduced. The specified resistance values are electrically matched to standard applications. Brake resistors have protection class IP65 and are UL-recognised.

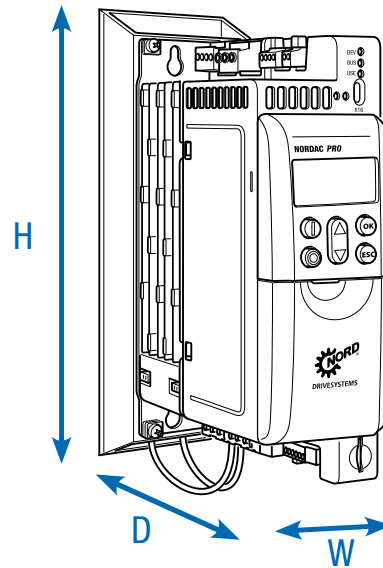

Frequency inverters SK 5xxP ...	Resistor type Material No.	Resistance [Ω]	Continuous output [W]	Short-term power [kW] ¹	(Overall) dimensions L x W x D [mm]
3~230 V	0.25 ... 0.75 kW SK BRU5-1-240-050 275 299 004	240	50	0.75	240 x 66 x 176
	1.1 ... 2.2 kW SK BRU5-2-075-200 275 299 210	75	200	3.0	280 x 66 x 176
3~400 V	0.25 ... 0.75 kW SK BRU5-1-400-100 275 299 101	400	100	1.5	240 x 66 x 176
	1.1 ... 2.2 kW SK BRU5-2-220-200 275 299 205	220	200	3.0	280 x 66 x 176
	3.0 ... 5.5 kW SK BRU5-3-100-300 275 299 309	100	300	4.5	340 x 91 x 210
	7.5 ... 11.0 kW SK BRU5-4-044-400 275 299 512	44	400	7.5	385 x 91 x 210
Temperature monitoring for SK BR5 resistors with installation close to the inverter 275 991 100			Bimetallic switch as opener Nominal switching temperature: 180°C		Broad brake resistor + 10 mm (on one side)
Temperature monitoring for SK BR5 resistors with direct installation under the frequency inverter 275 991 200			Bimetallic switch as opener Nominal switching temperature: 100°C		The dimensions apply to the frequency inverter, including the braking resistor

¹ Once within 120 s,
for a maximum duration of 1.2 s

Chassis braking resistors, SK BR2

The resistor elements are integrated into a housing cage and must be connected to the particular frequency inverter via a separate connecting cable.

The brake resistors must be mounted horizontally (apart from SK BR2-xxx/400-C).

A shielded cable which is as short as possible should be used for this purpose.

The brake resistors have protection class IP20 and are UL-recognised.

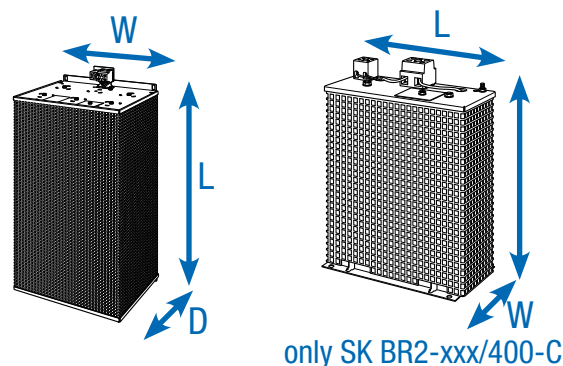

Frequency inverters SK 5xxP ...	Resistor type Material No.	Resistance [Ω]	Continuous output [W]	Short-term power [kW] ¹	(Overall) dimensions L x W x D [mm]
3~ 400 V	3.0 ... 4.0 kW SK BR2-100/400-C ¹ 278 282 040	100	400	12.0	178 x 100 x 252
	5.5 ... 7.5 kW SK BR2-60/600-C 278 282 060	60	600	18.0	385 x 92 x 120
	11.0 ... 15.0 kW SK BR2-30/1500-C 278 282 150	30	1500	45.0	585 x 185 x 120
	18.5 ... 22.0 kW SK BR2-22/2200-C 278 282 220	22	2200	66.0	485 x 275 x 120
	30.0 ... 37.0 kW SK BR2-12/4000-C 278 282 400	12	4000	120.0	585 x 266 x 210
	45.0 ... 55.0 kW SK BR2-8/6000-C 278 282 600	8	6000	180.0	395 x 490 x 260
	75.0 ... 110 kW SK BR2-6/7500-C 278 282 750	6	7500	225.0	595 x 490 x 260
	132 ... 160 kW SK BR2-3/7500-C 278 282 753	3	7500	225.0	595 x 490 x 260
	132 ... 160 kW SK BR2-3/17000-C 278 282 754	3	17 000	510.0	795 x 490 x 260

Temperature monitoring for SK BR2 resistors integrated (2 terminals 4 mm²)

Bimetallic switch as opener.
Nominal switching temperature: 180°C.

¹ Type of assembly: vertical

² Once within 120 s,
for a maximum duration of 1.2 s

NORDAC *PRO* frequency inverters

Accessories



Signal converter +/- 10 V

For connection of a bipolar analogue signal to the unipolar analogue input of a frequency inverter, top-hat rail mounting.

Material No.: 278 910 320



Electronic brake rectifier SK EBGR-1

For direct control and supply of an electromagnetic holding brake.

Material No.: 19 140 990



IO expansion SK EBIOE-2

The generous number of standard inputs and outputs on the device can be supplemented using an extension provided for top-hat rail mounting.

Material No.: 275 900 210

Available for SK 530P and higher



NORDAC *ACCESS BT*

Bluetooth adapter SK TIE5-BT-STICK to establish wireless connection between the frequency inverter and mobile terminal devices (e.g. smartphone, tablet). Together with the free NORDCON *APP* for Android or iOS, NORD therefore provides a smart aid for control, parameterisation and troubleshooting of frequency inverters.

Material No.: 275 900 120

MicroSD card, 128 MB

Removable data carrier for archiving and transfer of parameter data sets for the frequency inverter.

Material No.: 275 292 200

Available for SK 530P and higher



EMV-Kit

For EMC-compliant connection of shielded cables and to produce strain relief.

Depending on size and configuration level, various EMC kits are optionally available.

Size of frequency inverter	Shield Motor connection ①	Shield IO ports ②	Shield Control terminals (SK CU5-...) ¹ ③
1	SK HE5-EMC-MS-HS12 275 292 300	SK HE5-EMC-IS-HS1 275 292 304	SK HE5-EMC-CS-HS1 275 292 310
2	SK HE5-EMC-MS-HS12 275 292 300	SK HE5-EMC-IS-HS2 275 292 305	SK HE5-EMC-CS-HS23 275 292 311
3	SK HE5-EMC-MS-HS34 ² 275 292 301	SK HE5-EMC-IS-HS34 275 292 306	SK HE5-EMC-CS-HS23 275 292 311
4	SK HE5-EMC-MS-HS34 ² 275 292 301	SK HE5-EMC-IS-HS34 275 292 306	
5	SK HE5-EMC-MS-HS5 ² 275 292 302	SK HE5-EMC-IS-HS5 275 292 308	
6	SK HE5-EMC-MS-HS6 ² 275 292 303		
7 and 8	SK EMC 2-6 275 999 061		
9 and 10	SK EMC 2-7 275 999 071		

¹ Available for SK 530P and higher only in combination with (1) "motor connection shield"

² Two-part



CANopen® connection

The CANopen® interface is equipped with a 4-pole screw terminal as standard.

The following alternatives are optionally available.

Designation	Material No.	Description
SK TIE5-CAO-WIRE-2X4P	275 292 201	CANopen® double terminal (screw terminal, 2x4-pole)
SK TIE5-CAO-2X-RJ45	275 292 202	CANopen® RJ45 adapter



Optional:
RJ45 adapter for
CANopen

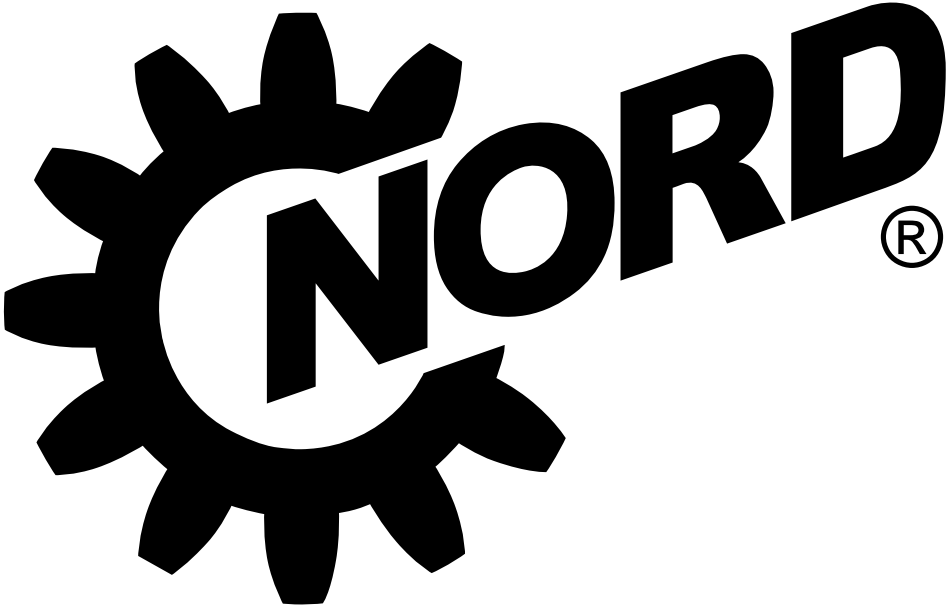

DRIVESYSTEMS



Frequency inverter for control cabinet application

NORDAC *PRO* SK 500E series

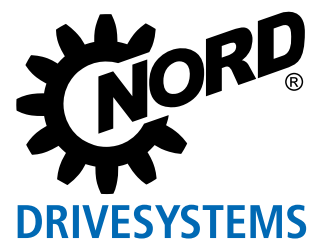

Powerful and versatile NORDAC PRO, SK 500E series



[NORDAC PRO - SK500E](#)

NORDAC PRO SK 500E frequency inverters are available for motors with rated powers of 0.25 – 160 kW. With a very compact design they are perfect for space-saving installation in control cabinets.

Notable features across the entire product line include:

- ▶ Sensorless current vector control which ensures constant speeds in case of fluctuating loads and very high torques during start-up
- ▶ 200% overload reserve which provides greater operational safety in cranes and lifting gear applications
- ▶ Operation of asynchronous and synchronous motors
- ▶ Integrated brake chopper for 4-quadrant operation
- ▶ Integrated line filter as the basis for optimal EMC performance

These features are as much a part of the basic configuration as the separately configurable PID or the process controller. These controllers independently carry out the control tasks in your application. The range is supplied with either an integrated 24 V power supply unit or a separate connection for the control board supply.

The advantage of externally powered frequency inverters is that access to parameter data and communication through any bus interfaces is possible even when the power is switched off. Moreover, an evacuation run controlled by the inverter can be performed, which constitutes an enormous boost in safety for lifting gear and similar safety-critical drive applications.

The SK 51xE and SK 530E and SK 535E models support the Safe Stop function according to EN 13849-1 (up to the maximum safety category 4, stop category 0 and 1). In addition, the SK 53xE version equipped with the built-in POSICON function makes it ideally suitable for all types of positioning tasks (relative and absolute). As standard, an integrated PLC on all SK 520E models and higher allows simple and free programming of drive-related functions in accordance with IEC 61131-3. In addition, the top model SK 540E/SK 545E features a universal encoder interface which allows connection of SSI or EnDat 2.1 encoders. The frequency inverters maintain uniform dimensions even with the different functional configurations.



Basic configuration

- Sensorless current vector control (ISD control) for high precision control and fast response times
- Brake management, electromechanical holding brake
- Brake chopper to divert generated energy to a brake resistor
- RS-232 diagnostic interface
- 4 switchable parameter sets for flexible use of parameter settings (e.g. switching between drive units with different motor data)
- All common drive functions such as acceleration/braking on a ramp
- Parameters pre-set with standard values, hence immediately ready for use
- Scalable display values
- Stator resistance measurement to ensure optimal control characteristics







Optional

- Interfaces for many bus systems
- Various control options (switches, potentiometers or parameterisation units)
- Variants with functional safety (Safe Stop (STO, SS1))
[Available for SK 510E and above](#)
[\(except for frequency inverters with mains voltages <230 V AC\)](#)
- Variants with incremental encoder interface for speed feedback (servo mode)
[Available for SK 520E and higher](#)
- Variants with PLC functionality
[Available for SK 520E and higher](#)
- POSICON variants with positioning function (relative and absolute)
[Available for SK 530E and higher](#)
- Universal encoder interface
[Available for SK 540E and higher](#)

Standards and approvals

All devices of the entire series comply with the standards and directives listed below.

Approval	Directive	Applied standards	Certificates	Code
CE (European Union)	Low Voltage Directive 2014/35/EU	EN 61800-5-1 EN 60529	C310600	
	EMC 2014/30/EU	EN 61800-3 EN 63000		
	RoHS 2011/65/EU	EN 61800-9-1 EN 61800-9-2		
	Delegated directive (EU) 2015/863			
	Ecodesign 2009/125/EG			
	Regulation (EU) Ecodesign 2019/1781			
	UL (USA)			
CSA (Canada)		C22.2 No.274-13	E171342	
RCM (Australia)	F2018L00028	EN 61800-3	133520966	
EAC (Eurasia)	TR CU 004/2011, TR CU 020/201	IEC 61800-5-1 IEC 61800-3	N RU Д-DE. HB27.B.02721/ 20	
UkrSEPRO (Ukraine)		EN 61800-5-1 EN 60529 EN 61800-3 EN 63000 EN 60947-1 EN 60947-4 EN 61558-1 EN 50581	C311900	
UKCA (United Kingdom)		EN 61800-5-1 EN 60529 EN 61800-3 EN 63000 EN 61800-9-1 EN 61800-9-2	C350600	

Introduction
NORDAC PRO SK 500P
NORDAC PRO SK 500E
NORDAC LINK
NORDAC ON
NORDAC FLEX
NORDAC BASE
NORDAC START
Accessories

Type code

Frequency inverters

SK 530E-370-323-A(-CP)

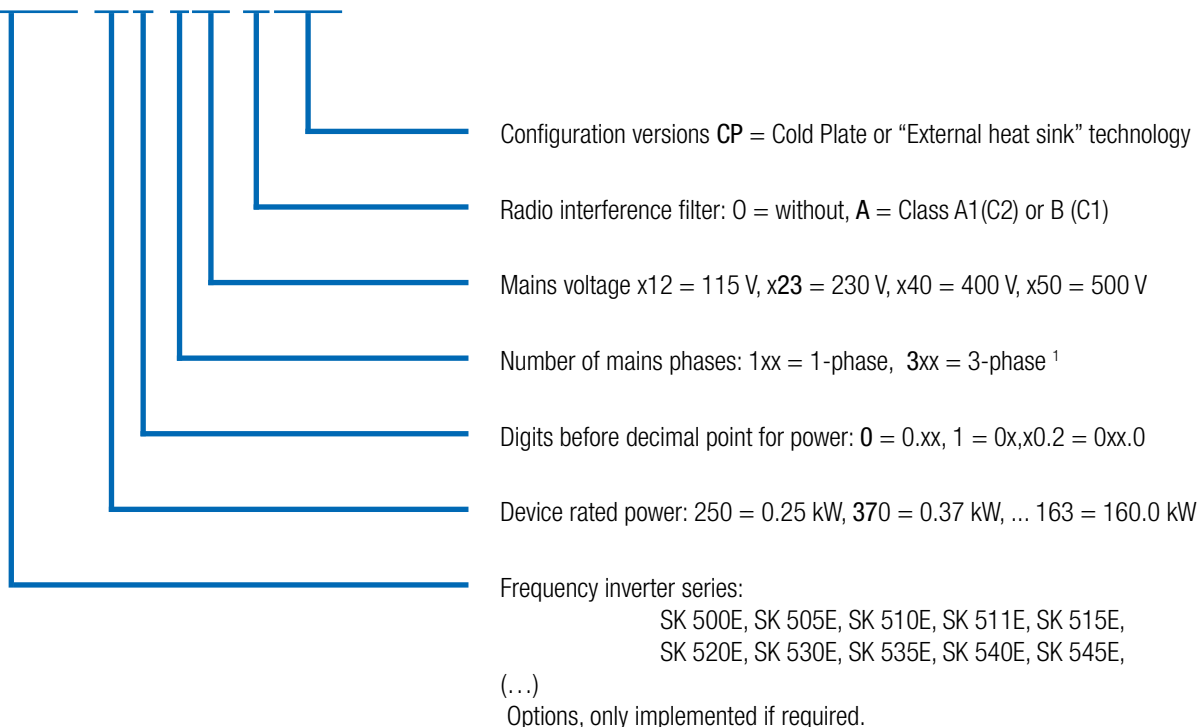

¹ Designation -3 also includes combined devices which are intended for single and three-phase operation (please refer to the technical data)

Technologieboxen

SK TU3-PNT(-...)

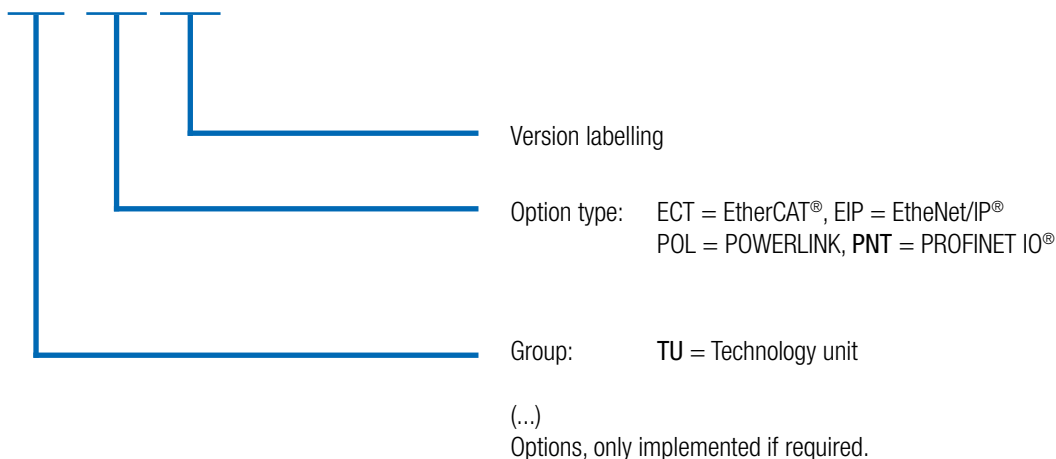

NORDAC PRO SK 500E

All versions at a glance

	SK 500E	SK 510E	SK 511E	SK 520E	SK 530E	SK 535E	SK 540E	SK 545E	SK 515E	SK 535E	SK 545E
	Size 1-4								Size 5-11		
Sensorless current vector control (ISD control)	●	●	●	●	●	●	●	●	●	●	●
Brake management for mechanical holding brake	●	●	●	●	●	●	●	●	●	●	●
Brake chopper (brake resistor optional)	●	●	●	●	●	●	●	●	●	●	●
RS-232 diagnostic interface	●	●	●	●	●	●	●	●	●	●	●
4 switchable parameter sets	●	●	●	●	●	●	●	●	●	●	●
All normal drive functions	●	●	●	●	●	●	●	●	●	●	●
Parameters pre-set with standard values	●	●	●	●	●	●	●	●	●	●	●
Stator resistance measurement	●	●	●	●	●	●	●	●	●	●	●
Energy-saving function, optimised efficiency in partial load operation	●	●	●	●	●	●	●	●	●	●	●
Integrated EMC line filter according to EN 61800-3, Category C2 up to 20 m motor cable, Category C1 up to 5 m motor cable (devices up to Size 4)	●	●	●	●	●	●	●	●	●	●	●
Monitoring functions	●	●	●	●	●	●	●	●	●	●	●
Load monitor	●	●	●	●	●	●	●	●	●	●	●
Link circuit coupling	●	●	●	●	●	●	●	●	●	●	●
Lifting gear functionality	●	●	●	●	●	●	●	●	●	●	●
PID controller	●	●	●	●	●	●	●	●	●	●	●
Process controller / compensator control	●	●	●	●	●	●	●	●	●	●	●
Synchronous motor operation (PMSM)	●	●	●	●	●	●	●	●	●	●	●
Cold plate up to Size 4, External heat sink technology up to Size 2	●	●	●	●	●	●	●	●	○	○	○
All common field bus systems	●	●	●	●	●	●	●	●	●	●	●
"Safe Stop" function (STO, SS1) (not for 115 V devices)	○	●	●	○	●	●	●	●	●	●	●
CANopen® on board	○	○	●	●	●	●	●	●	●	●	●
Evacuation run	○	○	○	○	○	●	●	●	●	●	●
Incremental encoder input (servo mode)	○	○	○	●	●	●	●	●	○	●	●
POSICON	○	○	○	○	●	●	●	●	○	●	●
Internal 24 V power supply unit to supply the control board	●	●	●	●	●	○	●	○	●	●	●
External 24 V power supply for the control board	○	○	○	○	○	●	○	●	●	●	●
Automatic switching between external and internal 24 V control voltage	○	○	○	○	○	○	○	○	●	●	●
PLC functionality	○	○	○	●	●	●	●	●	○	●	●
Universal encoder interface	○	○	○	○	○	○	●	●	○	○	●

- Available as standard
- Optional
- Not available

Introduction
NORDAC PRO SK 500P
NORDAC PRO SK 500E
NORDAC LINK
NORDAC ON
NORDAC FLEX
NORDAC FLEX
NORDAC BASE
NORDAC START
Accessories

	SK 500E	SK 510E	SK 511E	SK 520E	SK 530E	SK 535E	SK 540E	SK 545E	SK 515E	SK 535E	SK 545E	
	Size 1-4								Size 5-11			
Control terminals	DIN	5	5	5	7	7	7	5-7 ¹	5-7 ¹	5	7	6-8 ¹
	DOUT	0	0	0	2	2	2	3-1 ¹	3-1 ¹	0	2	3-1 ¹
	Signal relay ² (... 230 V AC, 2 A)	2	2	2	2	2	2	2	2	2	2	2
	AIN ³	2	2	2	2	2	2	2	2	2	2	2
	AOUT ³	1	1	1	1	1	1	1	1	1	1	1
	TF (PTC)	1 ⁴	1 ⁴	1 ⁴	1 ⁴	1 ⁴	1 ⁴	1	1	1	1	1
Encoder interfaces	TTL RS422	○	○	○	●	●	●	●	●	○	●	●
	HTL ^{4,5}	●	●	●	●	●	●	●	●	●	●	●
	CANopen®	○	○	○	○	●	●	●	●	○	●	●
	SIN / COS	○	○	○	○	○	○	●	●	○	○	●
	SSI	○	○	○	○	○	○	●	●	○	○	●
	BISS-C	○	○	○	○	○	○	●	●	○	○	●
	HIPERFACE	○	○	○	○	○	○	●	●	○	○	●
	EnDat 2.1	○	○	○	○	○	○	●	●	○	○	●
Communication	CAN / CANopen®	○	○	2	2	2	2	2	2	2	2	2
	RS485 / RS232	1	1	1	1	1	1	1	1	1	1	1
	RS485	○	○	○	1	1	1	1	1		1	1
	Modbus RTU	●	●	●	●	●	●	●	●	●	●	●

- ¹ 2 digital IOs optionally parameterisable as DIN or DOUT
- ² Parameterisable with DOUT functions
- ³ AIN/AOUT can also be used for digital signals.
AIN: 0(2) – 10 V, 0(4) – 20 mA, size 5 and above additionally ± 10 V
- ⁴ Function can only be implemented through a digital input,
- ⁵ speed control only available with SK 520E or higher.

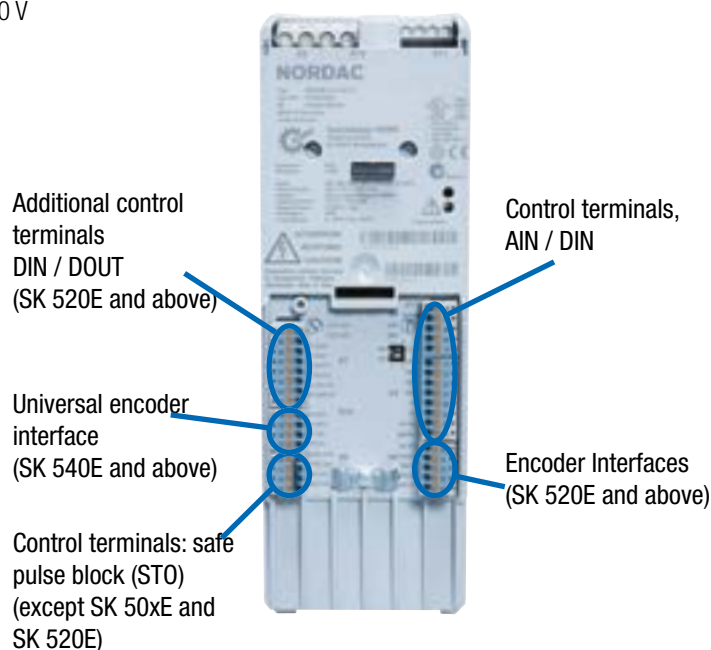
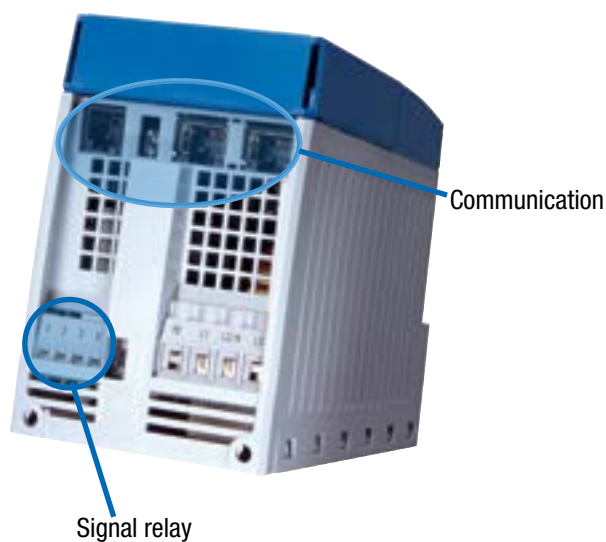

NORDAC *PRO* SK 500E frequency inverter

1~ 110 ... 120 V und 1 / 3~ 200 ... 240 V

Output frequency	0.0 ... 400.0 Hz	Protection class	IP20
Pulse frequency	3.0 ... 16.0 kHz	Regulation and control	Sensorless current vector control (ISD), linear V/f characteristic curve
Typical overload capacity	150 % for 60 s, 200 % for 3.5 s	Motor temperature monitoring	I ² t Motor PTC / bi-metal switch
Energy efficiency class	IE2	Leakage current	<30 mA, may be considerably less depending on the size and configuration of the frequency inverter (refer to the manual for details)
Frequency inverter efficiency	Size 1 -4 approx. 95 % Size 5 -7 approx. 97 % Size 8 -11 approx. 98 %		
Ambient temperature	0 °C ... +40 °C (S1) 0 °C ... +50 °C (S3, -70 % ED)		

Frequency inverters SK 5xxE ...	Nominal motor power		Nominal output current rms [A]	Mains voltage	Output voltage
	230 V [kW]	240 V [hp]			
-250-112-0	0.25	1/3	1.7	1~ 110 ... 120 V. +/- 10 %. 47 ... 63 Hz	3~ 0 - 2x mains voltage
-370-112-0	0.37	1/2	2.2		
-550-112-0	0.55	3/4	3.0		
-750-112-0	0.75	1	4.0		
-111-112-0	1.1	1 1/2	5.3		

Frequency inverters SK 5xxE ...	Nominal motor power		Nominal output current rms [A]	Mains voltage	Output voltage
	230 V [kW]	240 V [hp]			
-250-323-A	0.25	1/3	1,7	1 / 3~ 200 ... 240 V, +/- 10 %, 47 ... 63 Hz	3~ 0 up to mains voltage
-370-323-A	0.37	1/2	2,2		
-550-323-A	0.55	3/4	3,0		
-750-323-A	0.75	1	4,0		
-111-323-A	1.1	1 1/2	5,5		
-151-323-A	1.5	2	7,0		
-221-323-A	2.2	3	9,5		
-301-323-A	3.0	4	12,5		
-401-323-A	4.0	5	16,0		
-551-323-A	5.5	7 1/2	22.0		
-751-323-A	7.5	10	28.0	3~ 200 ... 240 V, +/- 10 %, 47 ... 63 Hz	
-112-323-A	11.0	15	46.0		
-152-323-A	15.0	20	60.0		
-182-323-A	18.5	25	73.0		

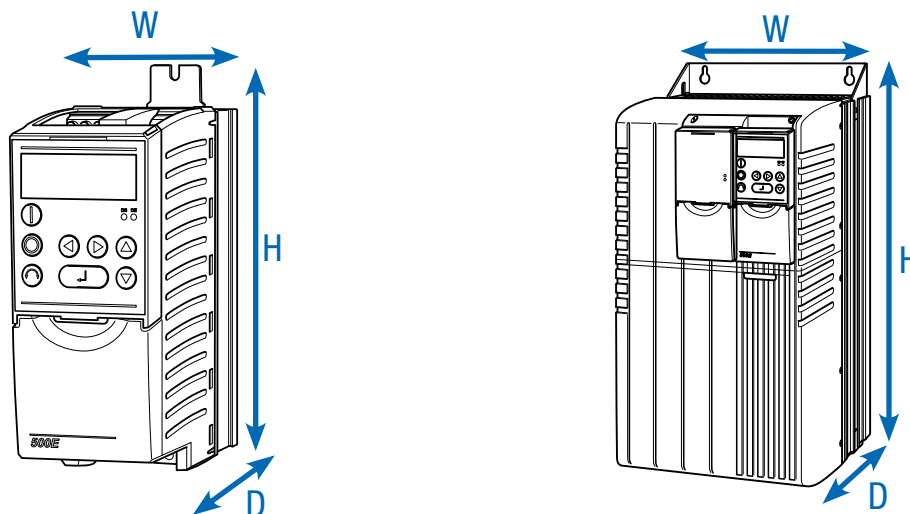

Frequency inverters SK 5xxE ...	Weight [kg]	(Overall) dimensions H x W x D [mm]	Size
-250-112-0	1.4	220 x 74 x 153	1
-370-112-0	1.4	220 x 74 x 153	1
-550-112-0	1.4	220 x 74 x 153	1
-750-112-0	1.4	220 x 74 x 153	1
-111-112-0	1.8	220 x 74 x 153	1

Frequency inverters SK 5xxE ...	Weight [kg]	(Overall) dimensions H x W x D [mm]	Size
-250-323-A	1.6	220 x 74 x 153	1
-370-323-A	1.6	220 x 74 x 153	1
-550-323-A	1.6	220 x 74 x 153	1
-750-323-A	1.6	220 x 74 x 153	1
-111-323-A	2.0	260 x 74 x 153	2
-151-323-A	2.0	260 x 74 x 153	2
-221-323-A	2.0	260 x 74 x 153	2
-301-323-A	2.7	275 x 98 x 181	3
-401-323-A	2.7	275 x 98 x 181	3
-551-323-A	8.0	357 x 162 x 224	5
-751-323-A	8.0	357 x 162 x 224	5
-112-323-A	10.3	397 x 180 x 234	6
-152-323-A	15.0	485 x 210 x 236	7
-182-323-A	15.0	485 x 210 x 236	7

NORDAC *PRO* SK 500E frequency inverter

3~ 380 ... 480 V

Output frequency	0.0 ... 400.0 Hz	Protection class	IP20
Pulse frequency	3.0 ... 16.0 kHz	Regulation and control	Sensorless current vector control (ISD), linear V/f characteristic curve
Typical overload capacity	150 % for 60 s, 200 % for 3.5 s	Motor temperature monitoring	I ² t Motor PTC / bi-metal switch
Frequency inverter efficiency	IE2 Size 1 -4 approx. 95 % Size 5 -7 approx. 97 % Size 8 -11 approx. 98 %	Leakage current	<30 mA, may be considerably less depending on the size and configuration of the frequency inverter (refer to the manual for details)
Ambient temperature	0 °C ... +40 °C (S1) 0 °C ... +50 °C (S3, -70 % ED)		

Frequency inverters SK 5xxE ...	Nominal motor power		Nominal output current rms [A]	Mains voltage	Output voltage
	400 V [kW]	480 V [hp]			
-550-340-A	0.55	3/4	1.7	3~ 380 ... 480 V, -20 % / +10 %, 47 ... 63 Hz	3~ 0 up to mains voltage
-750-340-A	0.75	1	2.3		
-111-340-A	1.1	1 1/2	3.1		
-151-340-A	1.5	2	4.0		
-221-340-A	2.2	3	5.5		
-301-340-A	3.0	4	7.5		
-401-340-A	4.0	5	9.5		
-551-340-A	5.5	7 1/2	12.5		
-751-340-A	7.5	10	16.0		
-112-340-A	11.0	15	24.0		
-152-340-A	15.0	20	31.0		
-182-340-A	18.5	25	38.0		
-222-340-A	22.0	30	46.0		
-302-340-A	30.0	40	60.0		
-372-340-A	37.0	50	75.0		
-452-340-A	45.0	60	90.0		
-552-340-A	55.0	75	110.0		
-752-340-A	75.0	100	150.0		
-902-340-A	90.0	125	180.0		
-113-340-A	110	150	220.0		
-133-340-A	132	180	260.0		
-163-340-A	160	220	320.0		

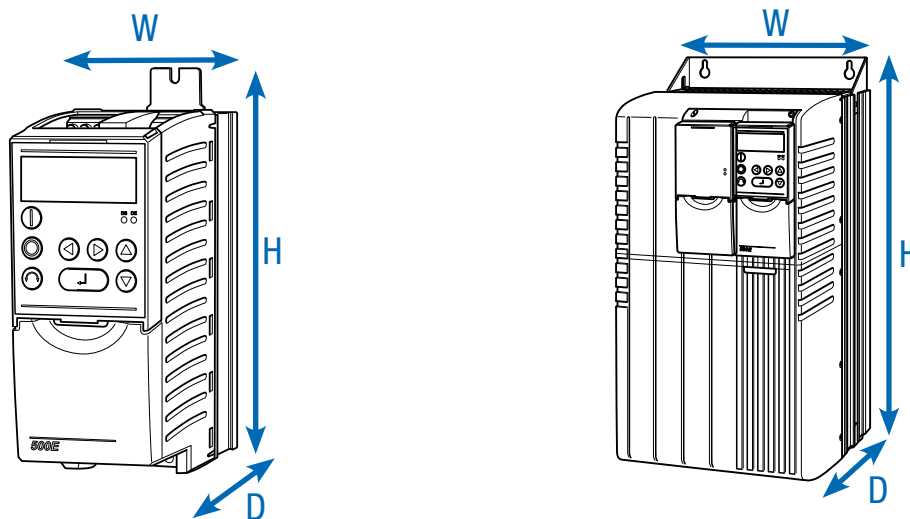

Frequency inverters SK 5xxE ...	Weight [kg]	(Overall) dimensions H x W x D [mm]	Size
-550-340-A	1.4	220 x 74 x 153	1
-750-340-A	1.4	220 x 74 x 153	1
-111-340-A	1.8	260 x 74 x 153	2
-151-340-A	1.8	260 x 74 x 153	2
-221-340-A	1.8	260 x 74 x 153	2
-301-340-A	2.7	275 x 98 x 181	3
-401-340-A	2.7	275 x 98 x 181	3
-551-340-A	3.1	320 x 98 x 181	4
-751-340-A	3.1	320 x 98 x 181	4
-112-340-A	8.0	357 x 162 x 224	5
-152-340-A	8.0	357 x 162 x 224	5
-182-340-A	10.3	397 x 180 x 234	6
-222-340-A	10.3	397 x 180 x 234	6
-302-340-A	16.0	485 x 210 x 236	7
-372-340-A	16.0	485 x 210 x 236	7
-452-340-A	20.0	598 x 265 x 286	8
-552-340-A	20.0	598 x 265 x 286	8
-752-340-A	25.0	636 x 265 x 286	9
-902-340-A	25.0	636 x 265 x 286	9
-113-340-A	46.0	720 x 395 x 292	10
-133-340-A	49.0	720 x 395 x 292	10
-163-340-A	52.0	799 x 395 x 292	11

Interfaces for operation, parameterisation and communication

Operation and parameterisation





Optional modules with up to 14 languages for displaying status and operational indicators, parameterisation and operation of the frequency inverter. In addition to

variants for direct mounting on the device or installation in a control cabinet door, handheld versions are also available. See also Accessories starting on page 165

Type	Designation	Material No.	Description	Remarks
	PotentiometerBox SK TU3-POT	275 900 110	Suitable for control, potentiometer 0 ... 100% .	Installation in the SK TU3 slot on the FI. ¹
	ParameterBox SK TU3-PAR	275 900 100	Suitable for control and parameterisation, LCD screen (illuminated), plain text display in 14 languages, memory for 5 device data sets, convenient control keypad.	Installation in the SK TU3 slot on the frequency inverter. ¹
	ControlBox SK TU3-CTR	275 900 090	Suitable for control and parameterisation, 4-digit, 7-segment display, convenient control keypad.	Installation in the SK TU3 slot on the FI. ¹
	SimpleBox SK CSX-0	275 900 095	Suitable for control and parameterisation, 4-digit, 7-segment display, direct control of a device, one-button operation.	The module is connected to the RJ 12 interface of the frequency inverter and does not occupy the option slot for SK TU3 modules. Simultaneous control of a bus interface is therefore possible. Mounted on the frequency inverter
	ParameterBox SK PAR-5H	275 281 614	Control and parameterisation, LCD (illuminated), plain text display in 14 languages, direct control of up to five devices, memory for five device data sets, convenient control keypad, communication via RS485, including 1.5 m connection cable. Handheld, suitable for installation in a control cabinet door. IP54	Connection for data exchange with NORDCON <i>STUDIO</i> to a PC (USB 2.0), (standard "USB-C" connection cable required, e.g. material number: 275 292 100) Power supply, e.g. directly via frequency inverter or PC
	SimpleControlBox SK CSX-3E	275 281 413	Suitable for control and parameterisation, 4-digit, 7-segment display, direct control of a frequency inverter, convenient control keypad.	Electrical data: 4.5 ... 30 V DC / 1.3 W, Supply e. g. directly via the frequency inverter. Control cabinet installation
	Control and parameterisation software NORDCON		Software for control and parameterisation as well as support for commissioning and fault analysis of NORD electronic drive technology. Parameter names in 14 languages	Free download: www.nord.com
	Bluetooth stick NORDAC <i>ACCESS BT</i> SK TIE5-BT-STICK	275 900 120	Interface for wireless connection to a mobile terminal device (e.g. tablet or smartphone) via Bluetooth. The NORDCON <i>APP</i> , the NORDCON software for mobile terminal devices, enables smart operation and parameterisation as well as commissioning assistance and fault analysis of NORD electronic drive technology.	Available free of charge for Android and iOS 

¹ Cannot be combined with other SK TU3 modules as only one slot is available on the device..

Industrial Ethernet, Field bus and IO extensions

Variant		Designation Material No.	Description Connection	Remarks
EtherCAT®		SK TU3-ECT 275 900 180	Ethernet-based bus interface Type EtherCAT®. 2 x RJ45	Baud rate: maximum 100 MBaud 24 V DC connection: via terminal Usable as a gateway to control up to a total of four frequency inverters.
EtherNet/IP®		SK TU3-EIP 275 900 150	Ethernet-based bus interface Type EtherNet / IP® 2 x RJ45	Baud rate: maximum 100 MBaud 24 V DC connection: via terminal Usable as a gateway to control up to a total of four frequency inverters.
POWERLINK		SK TU3-POL 275 900 140	Ethernet-based bus interface Type POWERLINK 2 x RJ45	Baud rate: maximum 100 MBaud 24 V DC connection: via terminal Usable as a gateway to control up to a total of four frequency inverters.
PROFINET IO®		SK TU3-PNT 275 900 190	Ethernet-based bus interface Type PROFINET IO®. 2 x RJ45	Baud rate: maximum 100 MBaud 24 V DC connection: via terminal Usable as a gateway to control up to a total of four frequency inverters.

Line filter

Improvement of EMC

General

Line filters are used to reduce the emission of electromagnetic interference. SK 500E series frequency inverters are equipped with an integrated class C2 (max. 20 m shielded motor cable) or class C1 (size 1-4, max. 5 m shielded motor cable) line filter. Various adaptive line filters are available for longer cable lengths or to improve interference suppression.

Chassis line filter, SK HLD

The line filter meets protection class IP20 and enables interference suppression Class C1 with max. 25 m shielded motor cable and Class C2 with max. 50 m cable.

The line filters are installed separately from the frequency inverter.

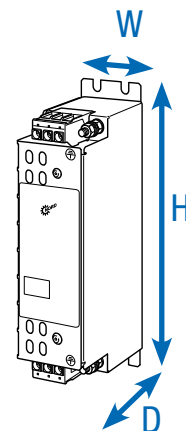

Frequency inverters SK 5xxE ...	Line filter type Material No.	Continuous current [A]	Leakage current ¹ [mA]	(Overall) dimensions H x W x D [mm]
3~ 230 V	0.25 ... 1.1 kW SK HLD 110-500/8 278 272 008	8.0	20 / 190	190 x 45 x 75
	1.5 ... 2.2 kW SK HLD 110-500/16 278 272 016	16.0	21 / 205	250 x 45 x 75
	3.0 ... 5.5 kW SK HLD 110-500/30 278 272 030	30.0	29 / 280	270 x 55 x 95
	7.5 kW SK HLD 110-500/42 278 272 042	42.0	30 / 290	310 x 55 x 95
	11 kW SK HLD 110-500/75 278 272 075	75.0	22 / 210	310 x 85 x 135
	15 ... 18.5 kW SK HLD 110-500/100 278 272 100	100.0	30 / 290	325 x 95 x 150
3~ 400 V	0.55 ... 2.2 kW SK HLD 110-500/8 278 272 008	8.0	20 / 190	190 x 45 x 75
	3.0 ... 5.5 kW SK HLD 110-500/16 278 272 016	16.0	21 / 205	250 x 45 x 75
	7.5 kW SK HLD 110-500/30 278 272 030	30.0	29 / 280	270 x 55 x 95
	11 kW SK HLD 110-500/42 278 272 042	42.0	30 / 290	310 x 55 x 95
	15 ... 18.5 kW SK HLD 110-500/55 278 272 055	55.0	30 / 290	255 x 85 x 95
	22 kW SK HLD 110-500/75 278 272 075	75.0	22 / 210	310 x 85 x 135
	30 kW SK HLD 110-500/100 278 272 100	100.0	30 / 290	325 x 95 x 150
	37... 45 kW SK HLD 110-500/130 278 272 130	130.0	22 / 210	325 x 95 x 150
	55 kW SK HLD 110-500/180 278 272 180	180.0	31 / 300	440 x 130 x 181
	75 ... 90 kW SK HLD 110-500/250 278 272 250	250.0	37 / 355	525 x 155 x 220

¹ Leakage current 1st value: rated for the maximum permissible input voltage fluctuation according to IEC 38 + 10%

Leakage current 2nd value: calculated at maximum input voltage and failure of 2 phases (typically at 50 Hz)

Bottom-mounted line filter, combination filter SK NHD

The line filter meets protection class IP20 and is available for frequency inverter powers of 7.5 kW (400 V). The line filter can be mounted flat underneath the frequency inverter. This reduces the space requirement. These combination filters combine the advantages of a line filter and a line choke in a single housing and enable class C1 interference suppression with max. 50 m shielded motor cable and class C2 with max. 100 m cable.

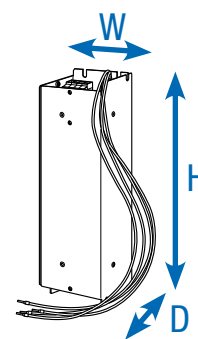

	Frequency inverters SK 5xxE ...	Line filter type Material No.	Continuous current [A]	Inductance [mH]	Leakage current ¹ [mA]	(Overall) dimensions H x W x D [mm]
3~ 230 V	0.25 ... 0.75 kW	SK NHD-480/6-F 278 273 006	5.5	3 x 6.4	7.7 / 74.4	290 x 88 x 74
	1.1 ... 2.2 kW	SK NHD-480/10-F 278 273 010	9.5	3 x 3.7	15.0 / 144.0	305 x 115 x 98
	3.0 ... 4.0 kW	SK NHD-480/16-F 278 273 016	16.0	3 x 2.2	21.5 / 206.5	350 x 140 x 98
3~ 400 V	0.55 ... 0.75 kW	SK NHD-480/3-F 278 273 003	2.3	3 x 15.3	4.3 / 40.0	250 x 75 x 60
	1.1 ... 2.2 kW	SK NHD-480/6-F 278 273 006	5.5	3 x 6.4	7.7 / 74.4	290 x 88 x 74
	3.0 ... 4.0 kW	SK NHD-480/10-F 278 273 010	9.5	3 x 3.7	15.0 / 144.0	305 x 115 x 98
	5.5 ... 7.5 kW	SK NHD-480/16-F 278 273 016	16.0	3 x 2.2	21.5 / 206.5	350 x 140 x 98

¹ Leakage current 1st value: rated for the maximum permissible input voltage fluctuation according to IEC 38 + 10%

Leakage current 2nd value: calculated at maximum input voltage and failure of 2 phases (typically at 50 Hz)

Line filter

Improvement of EMC

Bottom-mounted line filter, SK LF2

The line filter meets protection class IP00 and is available for frequency inverter powers of 37 kW (400 V). The line filter can be mounted flat underneath the frequency inverter.

This reduces the space requirement. These line filters enable class C1 interference suppression with max. 50 m shielded motor cable and class C2 with max. 100 m cable.

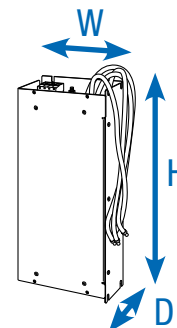

	Frequency inverters SK 5xxE ...	Line filter type Material No.	Continuous current [A]	Leakage current ¹ [mA]	(Overall) dimensions H x W x D [mm]
3~ 230 V	5.5 ... 7.5 kW	SK LF2-480/45-F 278 273 045	45.0	12 / 120	388 x 164 x 75
	11.0 kW	SK LF2-480/66-F 278 273 066	66.0	12 / 120	428 x 182 x 75
	15 ... 18.5 kW	SK LF2-480/105-F 278 273 105	105.0	22 / 210	527 x 210 x 95
3~ 400 V	0.55 ... 0.75 kW	SK LF2-480/2-F 278 273 002	2.3	6,4 / 61,5	250 x 75 x 48
	1.1 ... 2.2 kW	SK LF2-480/5-F 278 273 005	5.5	7.7 / 74.3	290 x 88 x 48
	3.0 ... 4.0 kW	SK LF2-480/9-F 278 273 009	9.5	19.5 / 187	305 x 115 x 54
	5.5 ... 7.5 kW	SK LF2-480/15-F 278 273 015	16.0	20.2 / 193	350 x 115 x 54
	11.0 ... 15.0 kW	SK LF2-480/45-F 278 273 045	45.0	12 / 120	388 x 164 x 75
	18.5 ... 22.0 kW	SK LF2-480/66-F 278 273 066	66.0	12 / 120	428 x 182 x 75
	30.0 ... 37.0 kW	SK LF2-480/105-F 278 273 105	105.0	22 / 210	527 x 210 x 95

¹leakage current 1st value: rated for the maximum permissible input voltage fluctuation according to IEC 38 + 10%

Leakage current 2nd value: calculated at maximum input voltage and failure of 2 phases (typically at 50 Hz)

Mains chokes

Reduction of mains feedback

General

It may be necessary for some drive systems to use mains chokes to reduce dangerous mains current peaks. With their use, external mains feedback effects are considerably reduced and the proportion of current harmonics is reduced to a minimum. The input current is reduced to approximately the value of the output current.

It is recommended that a mains choke be used at all times for a frequency inverter capacity of 45 kW and above. This will have an additional positive effect on device protection and EMC characteristics. All chokes have protection class IP00 and are UL-recognised.

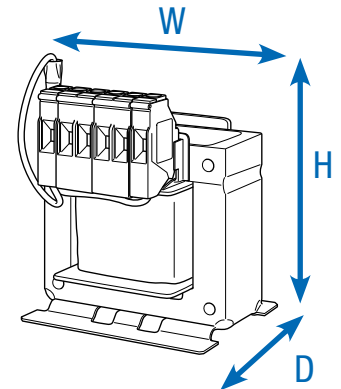

	Frequency inverters SK 5xxE ...	Choke type Material No.	Continuous current [A]	Inductance [mH]	(Overall) dimensions H x W x D [mm]
1~230V	0.25 ... 0.75 kW	SK CI1-230/8-C 278 999 030	8.0	2 x 1.0	89 x 65 x 78
	1.1 ... 2.2 kW	SK CI1-230/20-C 278 999 040	20.0	2 x 0.4	106 x 90 x 96
3~230V	0.25 ... 0.75 kW	SK CI1-480/6-C 276 993 006	6.0	3 x 4.88	117 x 96 x 60
	1.1 ... 1.5 kW	SK CI1-480/11-C 276 993 011	11.0	3 x 2.93	140 x 120 x 85
	2.2 ... 3.0 kW	SK CI1-480/20-C 276 993 020	20.0	3 x 1.47	177 x 155 x 110
	4.0 ... 7.5 kW	SK CI1-480/40-C 276 993 040	40.0	3 x 0.73	172 x 155 x 115
	11.0 ... 15.0 kW	SK CI1-480/70-C 276 993 070	70.0	3 x 0.47	220 x 185 x 122
	18.5 kW	SK CI1-480/100-C 276 993 100	100.0	3 x 0.29	263 x 240 x 148
3~400V	0.55 ... 2.2 kW	SK CI1-480/6-C 276 993 006	6.0	3 x 4.88	117 x 96 x 60
	3.0 ... 4.0 kW	SK CI1-480/11-C 276 993 011	11.0	3 x 2.93	140 x 120 x 85
	5.5 ... 7.5 kW	SK CI1-480/20-C 276 993 020	20.0	3 x 1.47	177 x 155 x 110
	11.0 ... 15.0 kW	SK CI1-480/40-C 276 993 040	40.0	3 x 0.73	172 x 155 x 115
	18.5 ... 30.0 kW	SK CI1-480/70-C 276 993 070	70.0	3 x 0.47	220 x 185 x 122
	37.0 ... 45.0kW	SK CI1-480/100-C 276 993 100	100.0	3 x 0.29	263 x 240 x 148
	55.0 ... 75.0 kW	SK CI1-480/160-C 276 993 160	160.0	3 x 0.18	268 x 352 x 140
	90.0 kW	SK CI1-480/280-C 276 993 280	280.0	3 x 0.10	268 x 352 x 169
	110 ... 132 kW	SK CI1-480/350-C 276 993 350	350.0	3 x 0.08	268 x 352 x 169
	160 kW	nicht verfügbar			

Link circuit choke

Reduction of mains feedback

Link circuit choke SK DCL

Similar to a mains choke, reduces the network loads of a frequency inverter that are inherent to its functional principle. It is connected to easily accessible contacts in the frequency inverter's intermediate circuit and is available for 45 kW and above. All chokes have protection class IP00 and are UL-recognised.

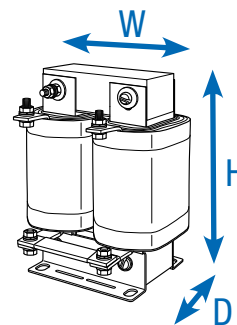

Frequency inverter SK 5xxE ...	Choke type Material No.	Continuous current [A]	Inductance [mH]	(Overall) dimensions H x W x D [mm]
45.0 ... 55.0 kW	SK DCL-950/120-C 276 997 120	120	0.50	230 x 148 x 147
75.0 ... 90.0 kW	SK DCL-950/200-C 276 997 200	200	0.30	260 x 170 x 153
110 kW	SK DCL-950/260-C 276 997 260	260	0.25	284 x 180 x 174
132 kW	SK DCL-950/320-C 276 997 320	320	0.20	282 x 180 x 189
160 kW	SK DCL-950/380-C 276 997 380	200	0.17	282 x 180 x 189

Motor chokes

Compensation of cable capacitances

General

Long motor cable lengths (cable capacity) often require the use of additional motor chokes (output chokes) on the frequency inverter output.

In addition, the use of motor chokes has a positive effect on device protection and EMC characteristics.

The specified motor chokes are rated for a pulse frequency of 3 to 6 kHz and an output frequency of 0 to 120 Hz. All chokes have protection class IP00 and are UL-recognised.

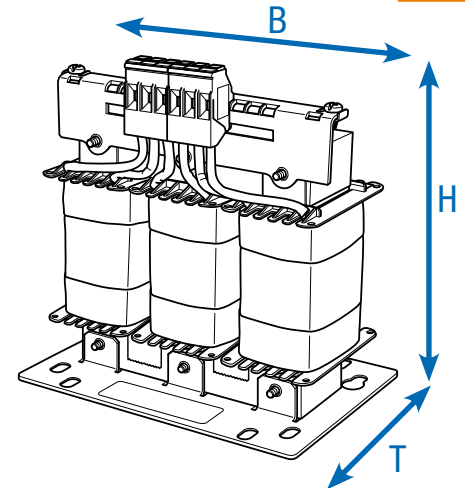

	Frequency inverter SK 5xxE ...	Choke type Material No.	Continuous current [A]	Inductance [mH]	(Overall) dimensions H x W x D [mm]
3~ 230 V	0.25 ... 0.75 kW	SK C01-460/4-C 276 996 004	4	3 x 3.5	140 x 120 x 104
	1.1 ... 1.5 kW	SK C01-460/9-C 276 996 009	9	3 x 2.5	160 x 155 x 110
	2.2 ... 4.0 kW	SK C01-460/17-C 276 996 017	17	3 x 1.2	201 x 185 x 102
	5.5 ... 7.5 kW	SK C01-460/33-C 276 996 033	33	3 x 0.6	201 x 185 x 122
	11.0 ... 15.0 kW	SK C01-480/60-C 276 992 060	60	3 x 0.33	210 x 185 x 112
	18.5 kW	SK C01-460/90-C 276 996 090	90	3 x 0.22	325 x 352 x 144
3~ 400 V	0.55 ... 1.5 kW	SK C01-460/4-C 276 996 004	4	3 x 3.5	140 x 120 x 104
	2.2 ... 4.0 kW	SK C01-460/9-C 276 996 009	9	3 x 2.5	160 x 155 x 110
	5.5 ... 7.5 kW	SK C01-460/17-C 276 996 017	17	3 x 1.2	201 x 185 x 102
	11.0 ... 15.0 kW	SK C01-460/33-C 276 996 033	33	3 x 0.6	201 x 185 x 122
	18.5 ... 30 kW	SK C01-480/60-C 276 992 060	60	3 x 0.33	210 x 185 x 112
	37.0 ... 45.0 kW	SK C01-460/90-C 276 996 090	90	3 x 0.22	352 x 144 x 325
	55.0 ... 75.0 kW	SK C01-460/170-C 276 996 170	170	3 x 0.13	320 x 412 x 200
	90.0 ... 110 kW	SK C01-460/240-C 276 996 240	240	3 x 0.07	320 x 412 x 225
	132 ... 160 kW	SK C01-460/330-C 276 996 330	330	3 x 0.03	268 x 352 x 188

Braking resistors for dynamic drive characteristics

Bottom-mounted braking resistors SK BR4

are available in four sizes for frequency inverter capacities of up to 7.5 kW (400 V). This brake resistor can be mounted flat or vertically, next to the frequency inverter. This reduces the space requirement.

The specified resistance values are electrically matched to standard applications.

All brake resistors have protection class IP40 and are UL-recognised.

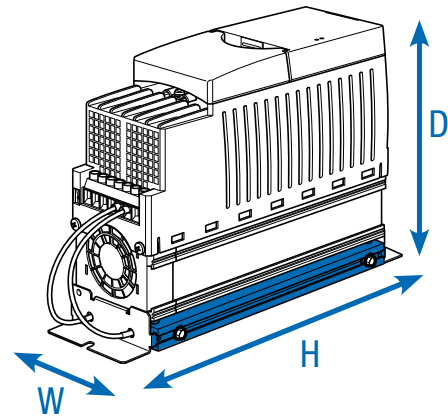

	Frequency inverter SK 5xxE ...	Resistor type Material No.	Resistance [Ω]	Continuous output [W]	Short-term power [kW] ¹	(Overall) dimensions L x W x D [mm]
1~/3~ 230V / 1~ 115V	0.25 ... 0.37 kW	SK BR4-240/100 275 991 110	240	100	2.2	230 x 88 x 175
	0.55 ... 0.75 kW	SK BR4-150/100 275 991 115	150	100	2.2	230 x 88 x 175
	1.1 ... 2.2 kW	SK BR4-75/200 275 991 120	75	200	4.4	270 x 88 x 175
	3.0 ... 4.0 kW	SK BR4-35/400 275 991 140	35	400	8.8	285 x 98 x 239
3~ 400 V	0.55 ... 0.75 kW	SK BR4-400/100 275 991 210	400	100	2.2	230 x 88 x 175
	1.1 ... 2.2 kW	SK BR4-220/200 275 991 220	220	200	4.4	270 x 88 x 175
	3.0 ... 4.0 kW	SK BR4-100/400 275 991 240	100	400	8.8	285 x 98 x 239
	5.5 ... 7.5 kW	SK BR4-60/600 275 991 260	60	600	13.0	330 x 98 x 239
	Temperature monitoring for SK BR4 resistors with installation close to the inverter 275 991 100		Bimetallic switch as opener Nominal switching temperature: 180°C		Broad brake resistor + 10 mm (on one side)	
	Temperature monitoring for SK BR4 resistors with direct installation under the frequency inverter 275 991 200		Bimetallic switch as opener Nominal switching temperature: 100°C		The dimensions apply to the frequency inverter, including the braking resistor	

¹ Once within 120 s,
for a maximum duration of 1.2 s

Chassis braking resistors, SK BR2

The resistor elements are integrated into a housing cage and must be connected to the particular frequency inverter via a separate connecting cable. The brake resistors must be mounted horizontally (apart from SK BR2-xxx/400-C). A shielded cable which is as short as possible should be used for this purpose.

All brake resistors have protection class IP20 and are UL-recognised.

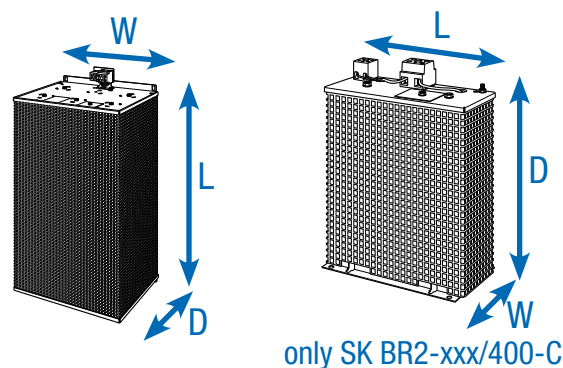

	Frequency inverter SK 5xxE ...	Resistor type Material No.	Resistance [Ω]	Continuous out- put [W]	Short-term power [kW] ²	(Overall) dimensions L x W x D [mm]
1~/3~ 230V / 1~ 115V	3.0 ... 4.0 kW	SK BR2-35/400-C ¹ 278 282 045	35	400	12	178 x 100 x 252
	5.5 ... 7.5 kW	SK BR2-22/600-C 278 282 065	22	600	18	385 x 92 x 120
	11.0 kW	SK BR2-12/1500-C 278 282 015	12	1500	45	585 x 185 x 120
	15.0 ... 18.5 kW	SK BR2-9/2200-C 278 282 122	9	2200	66	485 x 275 x 120
3~ 400 V	3.0 ... 4.0 kW	SK BR2-100/400-C ¹ 278 282 040	100	400	12	178 x 100 x 252
	5.5 ... 7.5 kW	SK BR2-60/600-C 278 282 060	60	600	18	385 x 110 x 120
	11.0 ... 15.0 kW	SK BR2-30/1500-C 278 282 150	30	1500	45	585 x 185 x 120
	18.5 ... 22.0 kW	SK BR2-22/2200-C 278 282 220	22	2200	66	485 x 275 x 120
	30.0 ... 37.0 kW	SK BR2-12/4000-C 278 282 400	12	4000	120	585 x 266 x 210
	45.0 ... 55.0 kW	SK BR2-8/6000-C 278 282 600	8	6000	180	395 x 490 x 260
	75.0 ... 110 kW	SK BR2-6/7500-C 278 282 750	6	7500	225	595 x 490 x 260
	132 ... 160 kW	SK BR2-3/7500-C 278 282 753	3	7500	225	595 x 490 x 260
	132 ... 160 kW	SK BR2-3/17000-C 278 282 754	3	17 000	510	795 x 490 x 260

Temperature monitoring for SK BR2 resistors
integrated (2 terminals 4 mm²)

Bimetallic switch as opener.
Nominal switching temperature: 180°C.

¹ Type of assembly: vertical

² Once within 120 s,
for a maximum duration of 1.2 s

NORDAC *PRO* frequency inverters

Accessories



EMV-Kit

For EMC-compliant connection of shielded cables and to produce strain relief.

Size of frequency inverter	EMV-Kit	Material No.
Size 1 and size 2	SK EMC 2-1	275 999 011
Size 3 and size 4	SK EMC 2-2	275 999 021
Size 5	SK EMC 2-3	275 999 031
Size 6	SK EMC 2-4	275 999 041
Size 7	SK EMC 2-5	275 999 051
Size 8 and size 9	SK EMC 2-6	275 999 061
Size 10 and size 11	SK EMC 2-7	275 999 071



Connection Kit HTL encoder WK 4/2/4*680 OHM

For connection of an HTL encoder to the TTL encoder input of the frequency inverter, top-hat rail mounting.

Material No.: 278 910 340



RJ45 WAGO connection module

For example to connect a CANopen® encoder to one of the two RJ45 connection sockets of the frequency inverter.
Material No.: 278 910 300



Signal converter +/- 10 V

For connection of a bipolar analogue signal to the unipolar analogue input of a frequency inverter (up to size 4), top-hat rail mounting.
Material No.: 278 910 320



IO expansion SK EBIOE-2

The generous number of standard inputs and outputs on the device can be supplemented using an extension provided for top-hat rail mounting.
Material No.: 275 900 210
[Available for SK 540E and higher](#)



Electronic brake rectifier SK EBGR-1

For direct control and supply of an electromagnetic holding brake.
Material No.: 19 140 990



Adapter module V/I CONVERTER 10 V/20 mA

The module serves the conversion of analogue (0–10 V) signals into equivalent current signals (0–20 mA).
Part no.: 278910315



Adapter module level adapter HTL – RS422

The module serves the conversion of HTL or TTL signals into complementary signals with RS422 levels, top-hat rail mounting
Part no.: 278910360



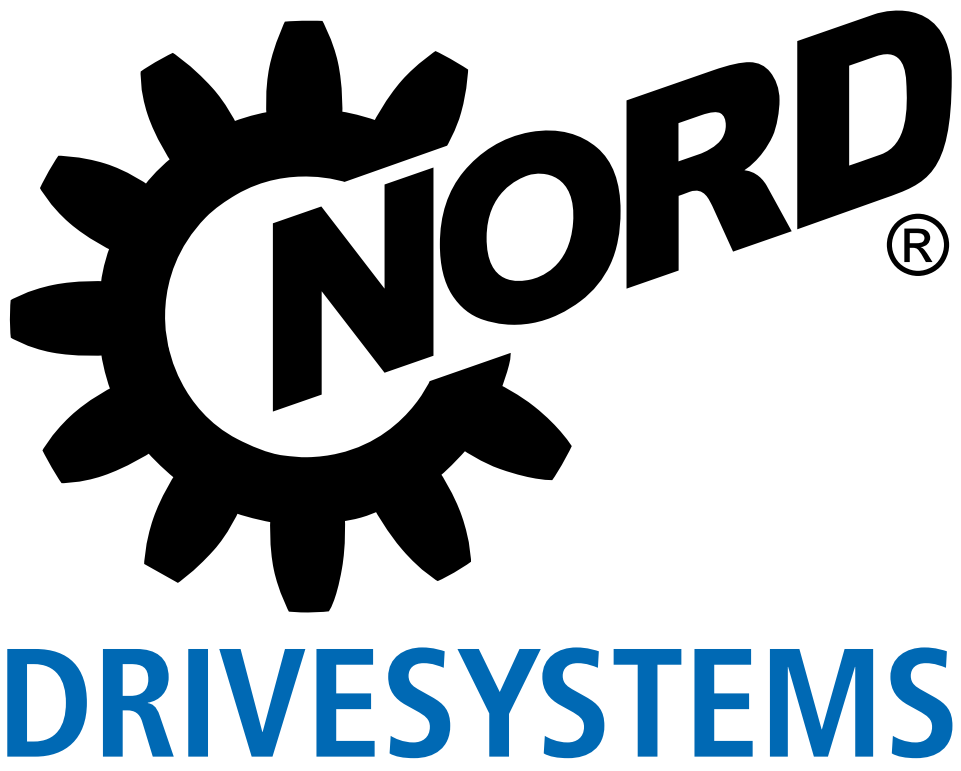



Field distributors NORDAC *LINK* for decentralised applications

Frequency inverter SK 250E-FDS, Motor starter SK 155E-FDS

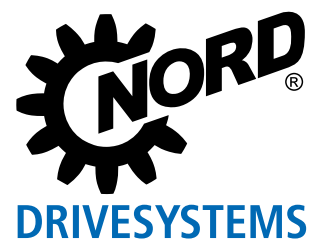

Easy connection NORDAC LINK, SK 250E-FDS and SK 155E-FDS series



[NORDAC LINK
Frequency inverter](#)



[NORDAC LINK
Motor starter](#)



General conveyor technology and intralogistics require drive control systems which can be installed easily and are easily accessible during operation or if maintenance is required. The NORDAC LINK field distribution system supplements the NORD DRIVESYSTEMS product range and provides customers with a drive control which can be flexibly installed close to the motor. System costs can be significantly reduced thanks to decentralised drive technology.

- ▶ Flexible configuration and function – freely configurable according to requirements and the application
- ▶ Available as frequency inverters (up to 7.5 kW) and motor starters (up to 3 kW)
- ▶ Fast commissioning due to simple operation
- ▶ Simple and reliable plug-in capability
- ▶ Simplified system maintenance due to integrated maintenance switch and local manual control facility
- ▶ Can be integrated into all common bus systems



Motor starters
Size 0
up to 0.75 kW
Size 1
up to 3.0 kW



Frequency inverter
Size 0
up to 0.75 kW
Size 1
up to 3.0 kW



Frequency inverter
Size 2
up to 7.5 kW

NORDAC LINK

extensive basic equipment



<ul style="list-style-type: none"> ▶ Monitoring of load torque depending on the output frequency ▶ Individual adaptation of load monitoring to protect the system from overload <p>Available in all inverters from SK 250E and higher</p>	Load monitor
<ul style="list-style-type: none"> ▶ High efficiency in partial load operation ▶ Reduced operating costs due to energy savings of up to 60% ▶ Simple setting <p>Available in all inverters from SK 250E and higher</p>	Energy-saving function
<ul style="list-style-type: none"> ▶ High-precision current vector control for rapid and precise load take-up ▶ Integrated brake chopper to divert generated energy to a brake resistor (braking resistor optional) ▶ Brake management for optimum control of an electro-mechanical holding brake for wear-free brake actuation <p>Available in all inverters from SK 250E and higher</p>	Lifting gear functions
<ul style="list-style-type: none"> ▶ Feedback and evaluation of actual values for implementation of closed circuit control e.g. flow or compensator control ▶ P and I components can be set separately <p>Available in all inverters from SK 250E and higher</p>	Process controller, PI controller
<ul style="list-style-type: none"> ▶ Control of one or more slave inverters by a master inverter ▶ Communication via USS or CANopen® with control word and setpoint values <p>Available in all inverters from SK 250E and higher</p>	Master / Slave operation
<ul style="list-style-type: none"> ▶ High-precision speed regulation ▶ Highest possible acceleration due to direct feedback of the actual speed characteristics to the frequency inverter and therefore also: <ul style="list-style-type: none"> ▶ Full torque down to standstill (speed 0) ▶ Digital speed controller with wide range of settings <p>Available in all inverters from SK 250E and higher</p>	Encoder feedback (Servo Mode)
<ul style="list-style-type: none"> ▶ Simple adaptation to control systems through optional interfaces ▶ Quick and simple diagnosis via easily visible LED indicators ▶ Various control boxes available for display, operation and parameterisation ▶ Simple operation and parameterisation through logical parameter structure and intuitive layout of control elements <p>Available in all inverters from SK 250E and higher</p>	Handling and communication
<ul style="list-style-type: none"> ▶ Bus systems – NORD supports all common bus systems to enable simple installation in the system design 	Bus systems
<ul style="list-style-type: none"> ▶ Functional safety - STO, SS1: Integrated, TÜV-certified safety functions simplify system design. <p>Available for SK 260E and SK 280E inverters</p>	Functional Safety
<ul style="list-style-type: none"> ▶ Functional safety in bus communication with PROFIsafe, integrated and TÜV-certified safety functions (SLS, SSR, SDI, SOS, SSM), connection and evaluation of a fail-safe SIN/COS encoder possible, 2 safe digital inputs (SI) and outputs (SO), max. 100 Mbaud, conformance class B and C, this option cannot be integrated later and must be specified during ordering <p>Available for SK 260E and SK 280E inverters in combination with SK CU4-PNS</p>	Functional safety in bus communication







Introduction
NORDAC PRO SK 500P
NORDAC PRO SK 500E
NORDAC LINK
NORDAC ON
NORDAC FLEX
NORDAC BASE
NORDAC START
Accessories

Standards and approvals

Type code

Motor starter field distributor

All devices of the entire series comply with the standards and directives listed below.

Approval	Directive	Applied standards	Certificates	Code
CE (European Union)	Low Voltage Directive 2014/35/EU	EN 60947-1 EN 60529	C310801	
	EMC 2014/30/EU	EN 60947-4-2 EN 630001		
	RoHS 2011/65/EU			
	Delegated directive (EU) 2015/863			
UL (USA)		UL 60947-1 UL 60947-4-2	E365221	
CSA (Canada)		C22.2 No.60947-1-13 C22.2 No.60947-4-2-14	E365221	
RCM (Australia)	F2018L00028	EN 60947-1 EN 60947-4-2	133520966	
EAC (Eurasia)	TR CU 004/2011, TR CU 020/2011	IEC 60947-1 IEC 60947-4-2	EAЭС N RU Д- DE.HB27.B. 02731/20	
UkrSEPRO (Ukraine)		EN 60947-1 EN 60529 EN 60947-4-2 EN 63000 EN 60947-1 EN 60947-4 EN 61558-1 EN 50581	C311900	
UKCA (United Kingdom)		EN 60947-1 EN 60529 EN 60947-4-2 EN 63000 EN 61800-9-1 EN 61800-9-2	C350801	

Introduction
NORDAC PRO SK 500P
NORDAC PRO SK 500E
NORDAC LINK
NORDAC ON
NORDAC FLEX
NORDAC BASE
NORDAC START
Accessories

SK 175E-FDS-301-340-A-AXS(-xxx)

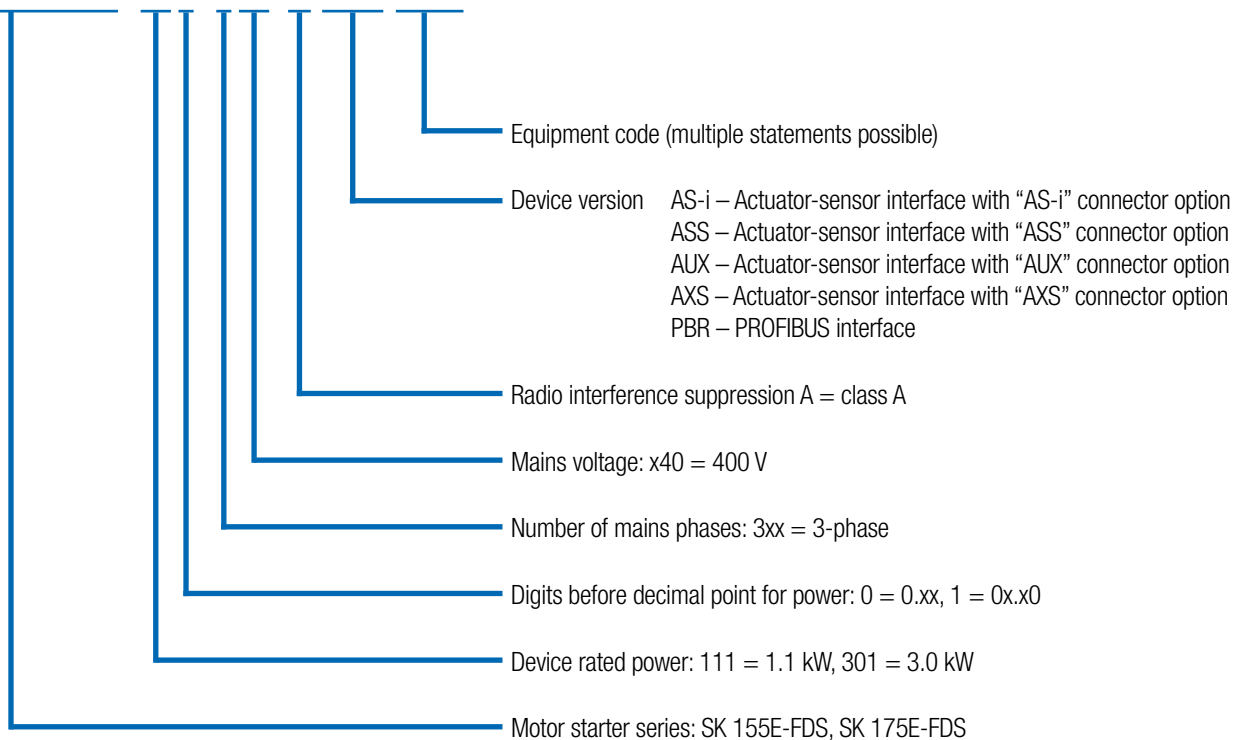







Standards and approvals

Type code

Field distributor frequency inverter

All devices of the entire series comply with the standards and directives listed below.

Approval	Directive	Applied standards	Certificates	Code	
CE (European Union)	Low Voltage Directive	EN 61800-5-1	C310701		
		2014/35/EU			EN 60529
	EMC	2014/30/EU			EN 61800-3
					EN 63000
	RoHS	2011/65/EU			EN 61800-9-1
					EN 61800-9-2
	Delegated directive (EU)	2015/863			
	Ecodesign	2009/125/EG			
	Regulation (EU)	2019/1781			
	Ecodesign				
UL (USA)		UL 61800-5-1	E171342		
CSA (Canada)		C22.2 No274-13	E171342		
RCM (Australia)	F2018L00028	EN 61800-3	133520966		
EAC (Eurasia)	TR CU 004/2011, TR CU 020/2011	IEC 61800-5-1 IEC 61800-3	EAЭС N RU Д-DE. HB27.B.02725/20		
UkrSEPRO (Ukraine)		EN 61800-5-1 EN 60529 EN 61800-3 EN 63000 EN 60947-1 EN 60947-4 EN 61558-1 EN 50581	C311900		
UKCA (United Kingdom)		EN 61800-5-1 EN 60529 EN 61800-3 EN 63000 EN 61800-9-1 EN 61800-9-2	C350900		

SK 250E-FDS-301-340-A (-xxx)

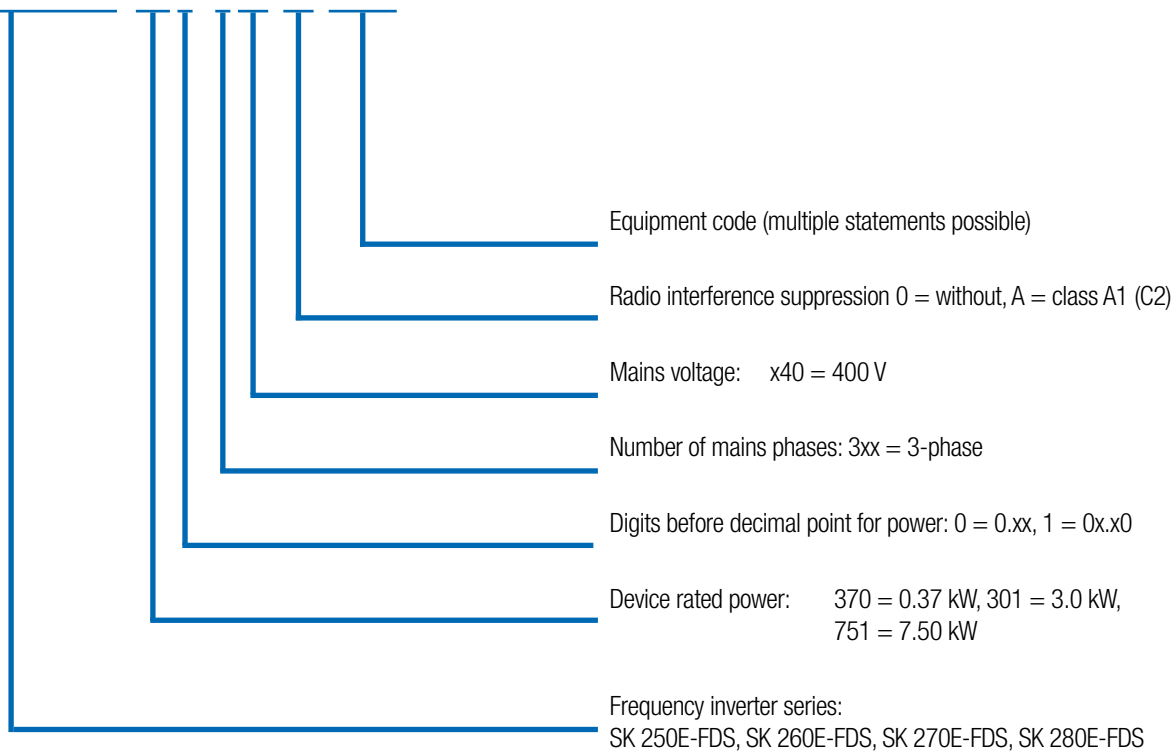

AS-Interface

Modern automation systems

Modern automation systems have a wide range of requirements, so that a suitable bus system and drive components must be selected in order to ensure efficient implementation.

AS-Interface

For the lower field level, the AS-Interface is a cost-effective solution which enables the networking of binary sensors and actuators. With NORDAC *LINK*, special versions which provide an appropriate solution by means of an AS-Interface, are available for this price-sensitive area.

The supply voltage (power) is connected separately via the corresponding plugs. Depending on the version of the device, the control voltage of the frequency inverter is generated either via an integrated power supply unit or is supplied separately via the yellow AS-Interface cable. This eliminates the need for an additional AUX cable (black). The type of addressing possible (standard or A/B slaves) also depends on the version of the device. The „ASI“ and „AUX“ variants are designed as double slave with the frequency inverter. With the double slave, there are two physical A/B slaves in the device which can be configured for extended data transfer according to the CTT2 protocol. Additional IO bits (1 x BUS IN + 2 x BUS OUT) are available for the so-called extended data transfer.

Available in the following devices:

SK 155E-FDS-...-ASI,
SK 175E-FDS-...-ASI,
SK 270E-FDS,
SK 280E-FDS

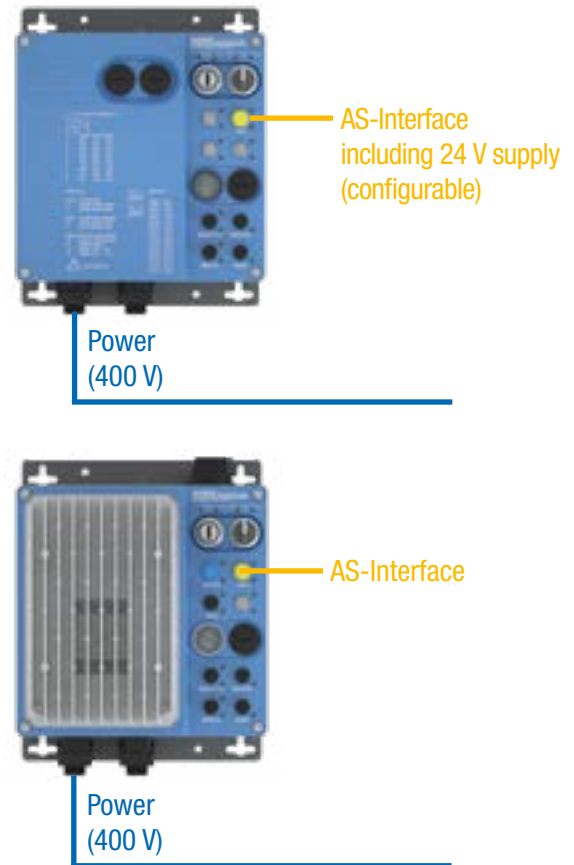

PROFIBUS DP®

This bus system allows for cyclic exchange of 4 control or 4 status bits via a process data object (with up to 12 Mbps). Addressing is performed via a rotary encoding switch. The PROFIBUS® termination resistor can be set via a standard M12 termination resistor. Connection is made with M12 plug connectors.

Available in all
SK 175E ... ASI devices

Variant	Slave profil	Slave typ	Control voltage	Inputs/Outputs	Configuration via parameters
-ASI	S-7.A	A/B-Slave	Yellow AS-I cableg	4I/40 + 1I/20 ¹	●
-AUX	S-7.A	A/B-Slave	Black AS-I cable	4I/40 + 1I/20 ¹	●
-AXS	S-7.0	Standard	Black AS-I cabl	4I/40	●

¹⁾ additionally available I/Os for configuration of CTT2 protocol
(only available with frequency inverter)

The entire team

All device versions at a glance

Introduction

NORDAC PRO SK 500P

NORDAC PRO SK 500E

NORDAC LINK

NORDAC ON

NORDAC FLEX

NORDAC BASE

NORDAC START

Accessories

	SK 155E-FDS	SK 175E-FDS	SK 250E-FDS	SK 260E-FDS	SK 270E-FDS	SK 280E-FDS
	Motor starters 0.06 - 3.0 kW			Frequency inverters 0.37 - 7.5 kW		
Plug connection of mains, motor and control cables	●	●	●	●	●	●
Energy bus - loop-through of mains supply cables	●	●	●	●	●	●
Repair/maintenance switch	●	●	●	●	●	●
Sensorless current vector control (ISD control)	○	○	●	●	●	●
Brake chopper (brake resistor optional)	○	○	●	●	●	●
RS-232/ RS-485 parameterisation and diagnostic interface (optional USB)	●	●	●	●	●	●
4 parameter sets, which can be switched over during operation	○	○	●	●	●	●
Parameters pre-set with standard values	●	●	●	●	●	●
Automatic determination of motor data	○	○	●	●	●	●
Energy-saving function, optimised efficiency in partial load operation	○	○	●	●	●	●
Integrated EMC line filters	according to EN 55011: Class A up to 20 m motor cable		according to EN 61800-3: Category C2 up to 10 m ¹ motor cable			
Drive unit monitoring function, including motor monitoring, motor thermistor evaluation	●	●	●	●	●	●
Reversing function	○	●	●	●	●	●
PI controller	○	○	●	●	●	●
Process controller / compensator control	○	○	●	●	●	●
Speed control (closed loop) with incremental encoder (HTL, RS485)	○	○	●	●	●	●
POSICon positioning with incremental encoder (HTL) or absolute encoder (CANopen [®])	○	○	●	●	●	●
PLC functionality	●	●	●	●	●	●
Synchronous motor operation (PMSM)	○	○	●	●	●	●
Modification for operation in IT network ²	●	●	●	●	●	●
Plug-in parameter storage (EEPROM) for additional data backup	○	○	●	●	●	●
All common field bus systems	○	○	●	●	●	●
Brake management for mechanical holding brake	●	●	●	●	●	●
Lifting gear functionality	○	○	●	●	●	●
Safe Stop function (STO, SS1)	○	○	○	●	○	●
Torque control and limitation	○	○	●	●	●	●
AS-Interface on board	○	● ³	○	○	●	●
PROFIBUS DP [®] on board	○	● ³	○	○	○	○
Internal 24 V power supply unit to supply the control board	●	●	●	●	●	●
Internal / external braking resistors	○	○	●	●	●	●
Local control elements (e.g switches, key switches)	●	●	●	●	●	●

¹ Cable-bound transmission only

² Must be taken into account for the order

³ Either AS-Interface or PROFIBUS[®] DP

● Available as standard

● Optional

○ Not available

	SK 155E-FDS	SK 175E-FDS	SK 250E-FDS	SK 260E-FDS	SK 270E-FDS	SK 280E-FDS
	Motor starters 0.06 - 3,0 kW		Frequency inverters 0.37 - 7.5 kW			
Interfaces and connections	3 (+2 sensor inputs for bus) ²		5+2 ^{1,2}			
Number of digital inputs	○ ○		2 ¹	2 ¹	2 ¹	2 ¹
Number of analogue inputs	○ ○		2 ¹	2 ¹	2 ¹	2 ¹
Number of digital outputs	2		2	2	2	2
Temperature sensor (PTC)	1		1	1	1	1
CANopen®	○ ○		●	●	●	●
RS485 encoder interface	○ ○		●	●	●	●
RS232 diagnostic interface	●		●	●	●	●

¹ Alternatively, the analogue inputs can also be used as digital inputs (not PLC-compatible).

² If necessary, individual inputs can be defined at the factory by the use of certain optional modules.

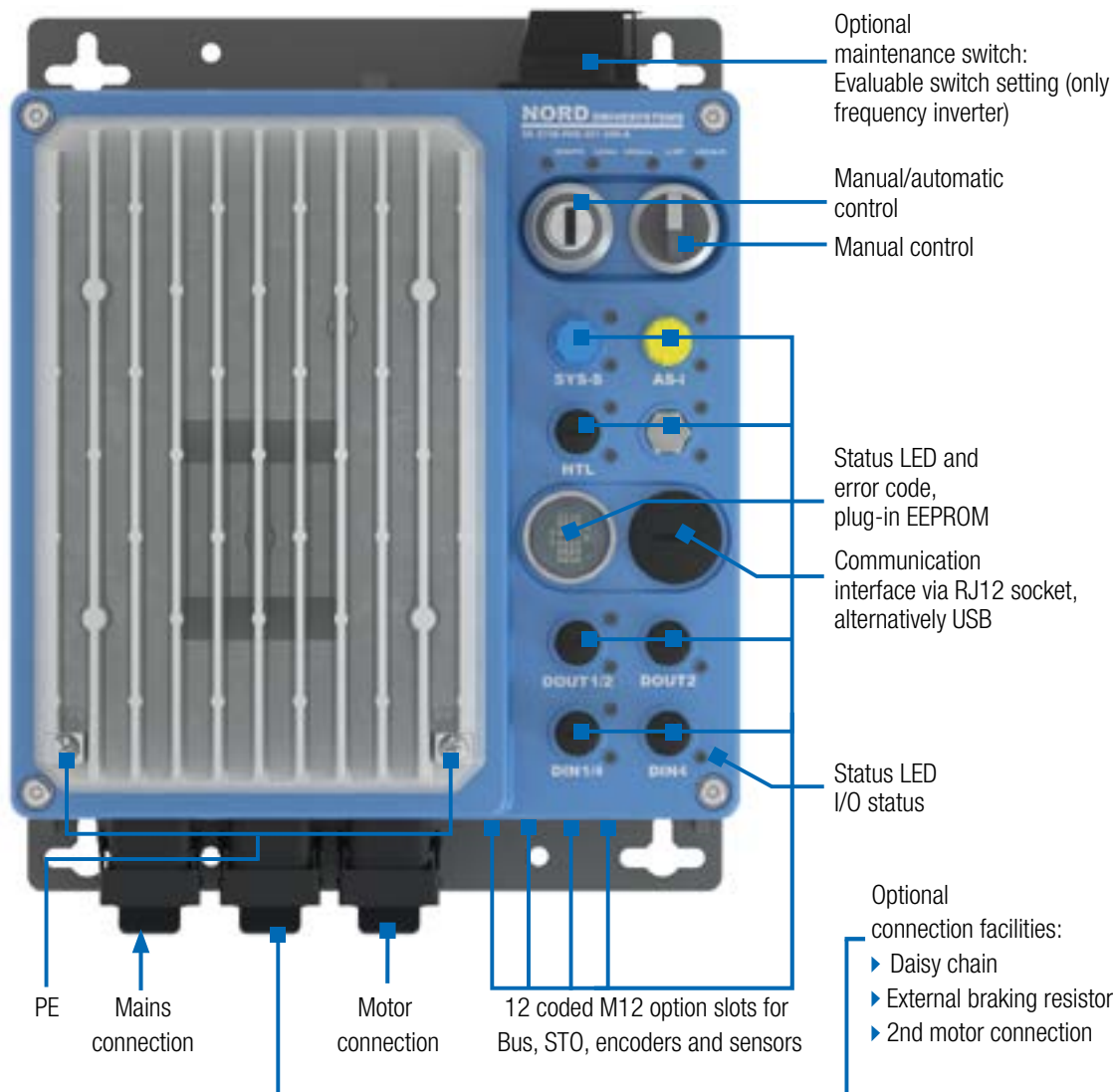



LED- status indicators use/meaning

The frequency inverter is equipped with LED indicator lights. These are used to indicate the signal statuses of the relevant option slot.

One option slot is closed with a transparent screw cap. The LED status indicator lights which are installed in this option slot act as diagnostic LEDs and are therefore always visible.

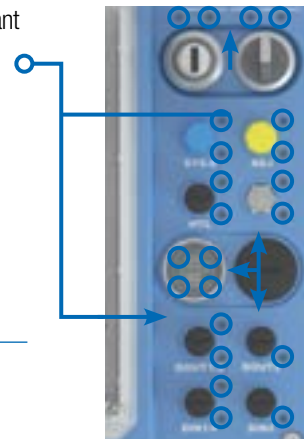

Ausführung LED-Anzeige	Use/Meaning
Yellow - Single colour - Static	Indication of the signal status („ON“ / „OFF“) or the associated function of the IOs.
Red/Green - Single or dual colour - Static or dynamic	Indication of the operating statuses on the inverter or communication level.

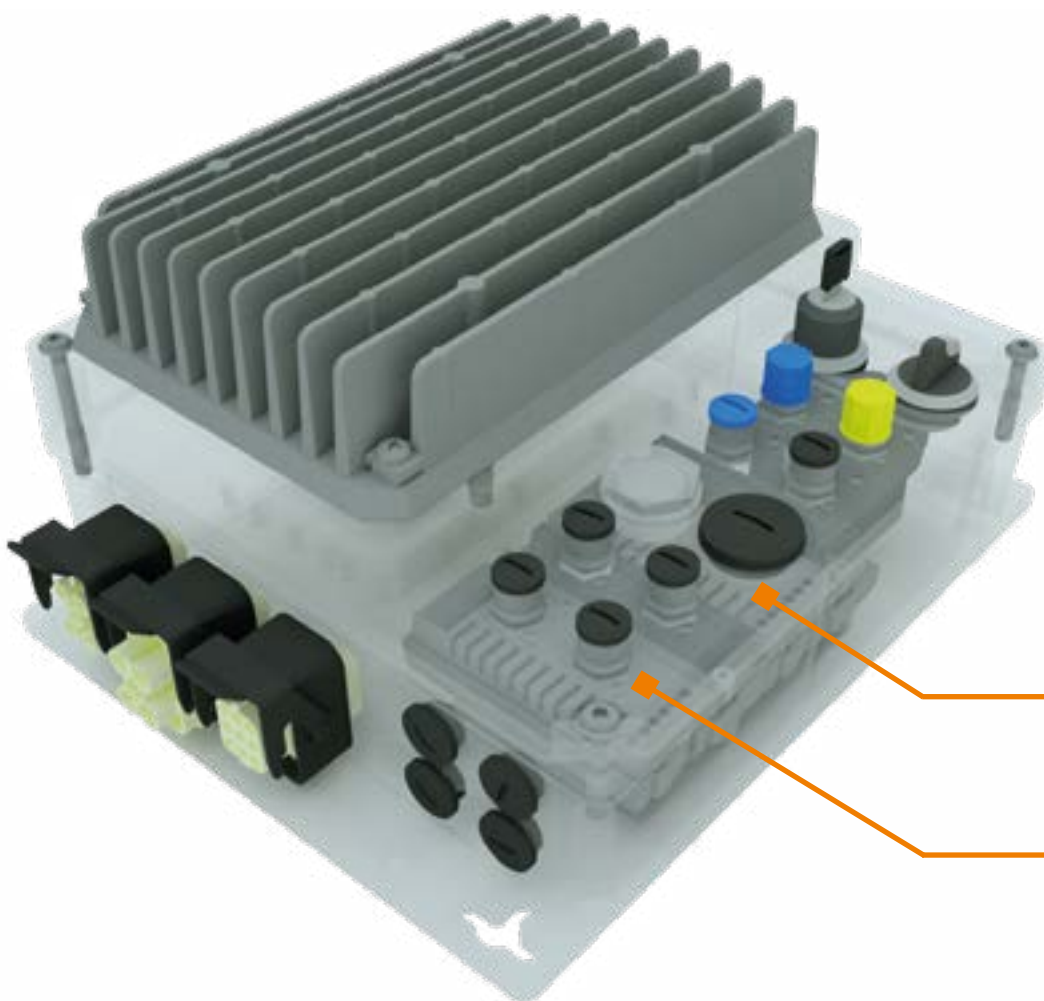

Can be extended with a maximum of two further option modules (SK CU4)

NORDAC LINK motor starter

3~ 380 ... 500 V

Typical overload capacity	150 % for 9 s up to 170 s (adjustable (shut-down class 5, 10 A, 10))	Protective measures against	<ul style="list-style-type: none"> ▶ Mains phase failure ▶ Motor phase failure ▶ Flux monitoring ▶ Motor over temperature (PTC) ▶ Motor overload ▶ Mains over/under voltage
Energy efficiency class	IE2	Motor temperature monitoring	1 [†] Motor PTC / bi-metal switch
Motor starter efficiency	> 98 %	Leakage current	< 20 mA
Ambient temperature	-25 °C...+50 °C (S1)		
Protection class	IP65 NEMA Type 1		

Motor starter SK 155E-FDS... / SK 175E-FDS...	Nominal motor power		Nominal out- put current rms [A]	Line voltage/ Output voltage	Weight [kg]	(Overall) dimensions H x W x D [mm]		Size
	[kW]	[hp]				H	D	
-111-340-B	up to 1.1	up to 1 1/2	3.2	3~ 380 V ... 500 V, -20 % / +10 %, 47 ... 63 Hz	approx.. 3	0	312 ¹ x 243 x 104 ²	
-301-340-B	up to 3.0	up to 4	7.5		approx. 3	1	312 ¹ x 243 x 104 ²	

¹ Without maintenance switch H=307 mm

² With key switch and key inserted D=125 mm

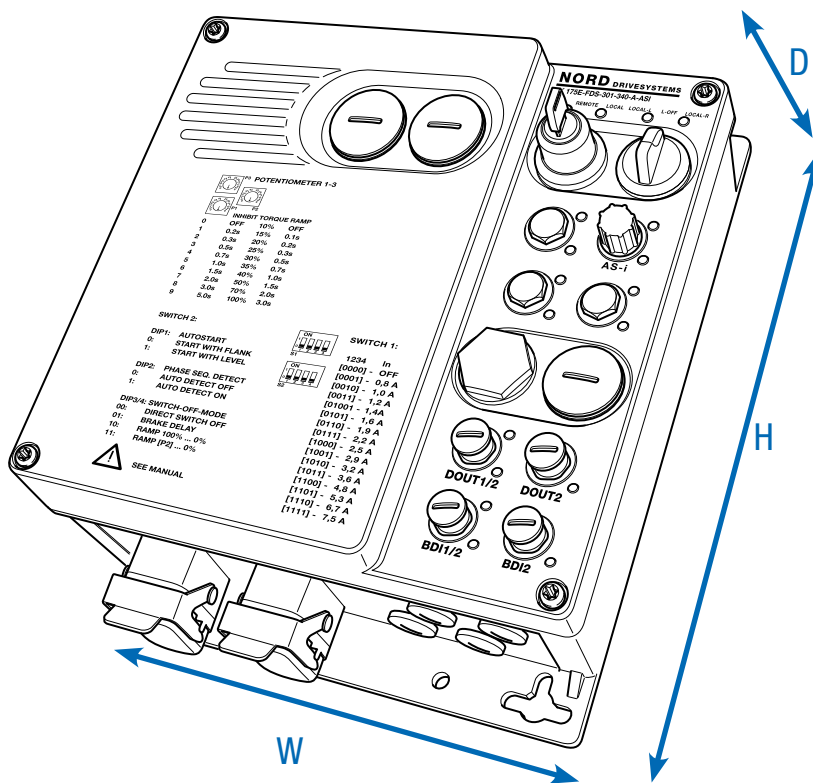

NORDAC LINK FREQUENCY INVERTER

3~ 380 ... 500 V



Output frequency	0.0 ... 400.0 Hz
Pulse frequency	3.0 ... 16.0 kHz
Typical overload capacity	150 % for 60 s, 200 % for 3.5 s
Energy efficiency class	IE2
Frequency inverter efficiency	> 95 %
Ambient temperature	-25 °C ... +40 °C (S1)

Protection class	IP65 devices up to 1.5 kW however not with option -FANO ¹ IP55 devices of 2.2 kW and higher as well as devices <2.2 kW, with option -FANO ¹ . NEMA Type 1
Regulation and control	Sensorless current vector control (ISD), linear V/f characteristic curve
Motor temperature monitoring	I ² t Motor PTC / bi-metal switch
Leakage current	< 30 mA

¹ (heat sink with mounted fan)

Frequency inverters SK 2xxE-FDS...	Nominal motor power		Nominal output current rms [A]	Line voltage/ Output voltage	Weight [kg]	(Overall)	Size	
	400 V [kW]	480 V [hp]				dimensions H x W x D [mm]		
-370-340-A	0.37	1/2	1.1	3 ~ 380...500 V, -20 % / +10 %, 47 ... 63 Hz	3.8	312 x 243 x 130	0	
-550-340-A	0.55	3/4	1.7		4.6	312 x 243 x 175 ¹	1	
-750-340-A	0.75	1	2.3		4.6	312 x 243 x 175 ¹	1	
-111-340-A	1.1	1 1/2	3.1		4.6	312 x 243 x 175 ¹	1	
-151-340-A	1.5	2	4.0		4.6	312 x 243 x 175 ¹	1	
-221-340-A	2.2	3	5.5		3 ~ AC 0 V up to mains voltage	4.8	312 x 243 x 175 ¹	1
-301-340-A	3.0	4	7.0			4.8	312 x 243 x 175 ¹	1
-401-340-A	4.0	5	8.9			6.8	312 x 358 x 184	2
-551-340-A	5.5	7	11.7		6.8	312 x 358 x 184	2	
-751-340-A	7.5	10	15.0		6.8	312 x 358 x 184	2	

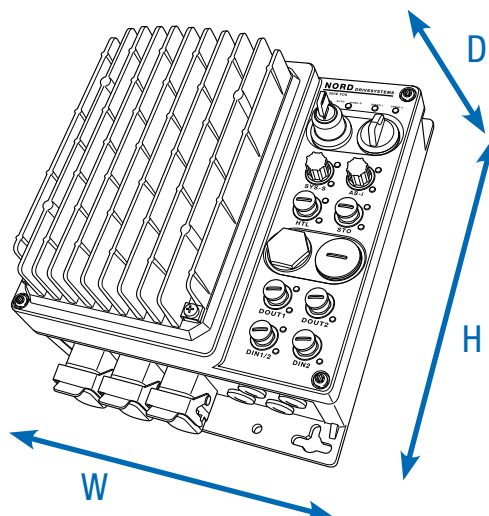

¹ Devices up to 1.5 kW power, without -FANO option (optional fan on heat sink) D=155

Introduction
NORDAC PRO SK 500P
NORDAC PRO SK 500E
NORDAC LINK
NORDAC ON
NORDAC FLEX
NORDAC BASE
NORDAC START
Accessories

Interfaces for operation, parameterisation and communication

Operation and parameterisation

Optional modules with up to 14 languages for displaying status and operational indicators, parameterisation and operation of the frequency inverter. In addition to variants for direct mounting on the device or installation in a control cabinet door, hand held versions are also available. See also Accessories starting on page 165

Type	Designation	Description	Remarks
	ParameterBox SK PAR-5H 275 281 614	Control and parameterisation, LCD (illuminated), plain text display in 14 languages, direct control of up to five devices, memory for five device data sets, convenient control keypad, communication via RS485, including 1.5 m connection cable. Handheld, suitable for installation in a control cabinet door. IP54	Connection for data exchange with NORDCON <i>STUDIO</i> to a PC (USB 2.0), (standard "USB-C" connection cable required, e.g. material number: 275 292 100) Power supply, e.g. directly via frequency inverter or PC
	SimpleControlBox SK CSX-3H 275 281 013	Control and parameterisation, 4-digit, 7-segment display, direct control of a device, convenient control keypad, including 2 m connection cable Handheld, IP54	Electrical data: 4.5 ... 30 V DC / 1.3 W, supply e. g. directly via the frequency inverter
	Control and parameterisation software NORDCON	Software for control and parameterisation as well as support for commissioning and fault analysis of NORD electronic drive technology. Parameter names in 14 languages	Free download: www.nord.com
	Bluetooth-Stick NORDAC <i>ACCESS BT</i> SK TIE5-BT-STICK 275 900 120	Interface for wireless connection to a mobile terminal device (e.g. tablet or smartphone) via Bluetooth. With the aid of the NORDCON APP, the NORDCON software for mobile terminal devices, enables smart operation and parameterisation as well as commissioning assistance and fault analysis of NORD electronic drive technology.	Available free of charge for Android and iOS 

Brake resistors for dynamic drive characteristics

Chassis braking resistors, SK BRW5

The resistor elements are integrated into a housing cage and must be connected to the particular frequency inverter via a separate connecting cable.

The brake resistors must be mounted horizontally. A shielded cable which is as short as possible should be used for this purpose.

The brake resistors have protection class IP65.

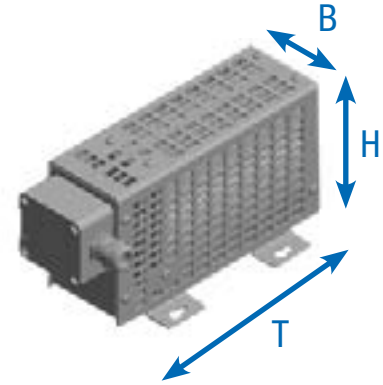

Frequency inverters SK 2xxE-FDS ...	Resistor type Material No.	Resistance [Ω]	Continuous output [W]	Short-term power [kW] ¹	(Overall) dimensions L x W x H [mm]
0,37 kW ... 2,2 kW	SK BRW5-1-300-225 278 281 070	300	225	4	245 x 120 x 123
3,0 kW ... 7,5 kW	SK BRW5-2-150-450 278 281 071	150	450	8	405 x 120 x 123

Temperature monitoring for SK BRW5 resistors integrated (2 terminals 4 mm)

Bimetallic switch as opener.
Nominal switching temperature: 180°C.

¹ Once within 120 s,
for a maximum duration of 1.2 s

External braking resistors

Like internal braking resistors, external braking resistors are intended for applications with low braking energy. Unlike internal braking resistors, their nominal continuous power is fully available. External braking resistors cannot be retrofitted and must therefore be taken into account in the order. The attachment increases the frequency inverter's width by 44 mm.

Available on request



Internal braking resistors

Internal brake resistors are intended for applications in which slight or only sporadic and brief braking (e.g. continuous conveyor equipment, mixing equipment) is to be expected. In addition, they enable the use of the frequency inverter in very confined spaces or in an explosive atmosphere.

Internal brake resistors cannot be retrofitted and must therefore be taken into account in the order.

For thermal reasons, the rated continuous output is limited to 25%.

Frequency inverters SK 2xxE-FDS-...	Resistance [Ω]	Continuous power P _n [W]	Power consumption ¹ P _{max} [kWs]
... 750-340-	400	100	1.0
... 151-340- bis ... 301-340-	400	100	1.0
... 401-340- bis ... 751-340-	200	200	2.0

¹ maximum once within 10s

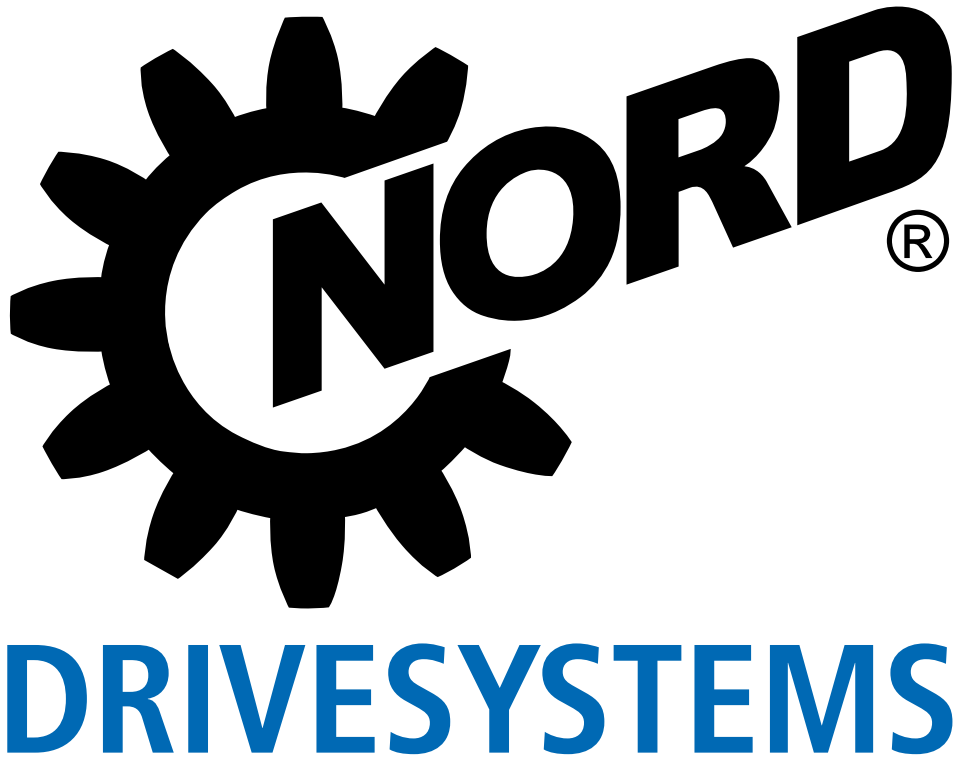



Frequency inverter for horizontal conveyor applications

NORDAC *ON* and *ON+* SK 300P series

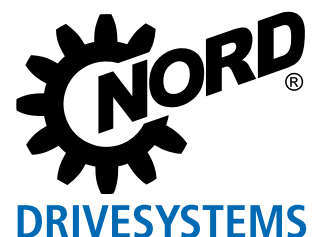

Top class inverter technology

NORDAC *ON*, SK 300P series



[NORDAC *ON*](#)

The NORDAC *ON* is a compact, smart frequency inverter for decentralised use that has been specially developed to meet the special requirements of horizontal conveyor technology, as well as for the interaction with the new IE5+ synchronous motor (NORDAC *ON+*).

Focused

The NORDAC *ON* is optimised for the common range of functions in horizontal conveyor technology. The following functions are included as standard:

- ▶ Integration of sensors via digital inputs
- ▶ If required, an integrated brake chopper dissipates regenerative energy to an optional braking resistor
- ▶ Brake management for optimum control of an electromagnetic holding brake for wear-free brake actuation
- ▶ Quick and simple diagnostics via easily visible LED indicators
- ▶ The Safe Torque Off (STO) function can be optionally integrated into the frequency inverter and is controlled via two safe inputs
- ▶ Other functional safety-related functions, for example SS2, SLS, SDI, SSM, SOS, SMS or SSR, can also be integrated. Communication is then possible via PNS or FSoE. - [in preparation](#)

Compact

The power range from 0.37 to 3.7 kW (NORDAC *ON/ON+*) or to 1.5 kW (NORDAC *ON PURE*) is covered by three sizes. Power-size assignments optimised this way allow for installations even in a very small space.

NORDAC *ON* was designed for use with asynchronous motors, whereas NORDAC *ON+* is intended for combination with synchronous motors and supplements the NORD high-efficiency portfolio around the new IE5+ motor generation.

In case the frequency inverter should or could not be mounted on the motor, it can alternatively be mounted on the wall to connect the converter close to the drive.



NORDAC *ON PURE*

PURE (in preparation)

NORDAC *ON PURE* extends the application area of the compact frequency inverter to applications in the food and beverage (F&B) industry.

Therefore, the device's housing has been specifically adjusted to the requirements in the F&B sector. Thanks to the **NXD tupH** surface treatment, the protection class achieves IP69, and all device openings have been reduced to a minimum.

Apart from the diagnostic opening, there are only robust M23 circular connectors for the hybrid connection of the mains/control voltage and the Ethernet connection.

The NORDAC *ON PURE* is intended for mounting on the equally F&B-enabled NORD IE5+ smooth motor (without ventilation) or alternatively as wall mounting option. Special hygienic cables are available for the electrical connection.



Digitalisation

As with all NORD frequency inverters, the new member of the NORDAC family is equipped with a powerful PLC for functions close to the drive. It can process the data from connected sensors and actuators, autonomously initiate control sequences and communicate drive and application data to the control centre, networked components or to cloud storage.

For this purpose, both frequency inverter versions have an integrated Ethernet interface and thus are ideally equipped for integration into modern automation systems. Whether for ProfiNet, EtherNet/IP or EtherCAT – the required protocol can be easily set via parameters.

100% Plug-and-play

All connections are pluggable and ensure quick, easy, error-minimised commissioning and maintenance on site. The 24 VDC supply for control and communication is also integrated in the 3-phase 400 V supply and is realised via a 6-pole plug connector. The daisy chain connector can be used to supply several drives in series in order to optimise the required cable length.

Robust

The frequency inverter housing is made entirely from aluminium and with a high IP protection class (up to IP66) it is thus also suitable for harsh environmental conditions.

In addition, the NORDAC *ON* / *ON+* can be operated in a temperature range from -30 to +40°C and can therefore also be used in deep-freeze applications.







NORDAC *ON*



NORDAC *ON*
Wandmontage-Variante

Standards and approvals

All devices across the entire series comply with the standards and directives listed below.

Approval	Directive	Applied standards	Certificates	Label
CE (European Union)	Low Voltage Directive 2014/35/EU	EN 61800-5-1 EN 60529	C310001	
	EMC 2014/30/EU	EN 61800-3 EN 63000		
	RoHS 2011/65/EU	EN 61800-9-1 EN 61800-9-2		
	Delegated directive (EU) 2015/863			
	Ecodesign 2009/125/EG			
	Regulation (EU) Ecodesign 2019/1781			
UL (USA)		UL 61800-5-1	E171342	
CSA (Kanada)		C22.2 No.274-13	E171342	
RCM (Australien)	F2018L00028	EN 61800-3	C310001	
EAC (Eurasien)	TR CU 004/2011, TR CU 020/2011	IEC 61800-5-1 IEC 61800-3	in preparation	
UkrSEPRO (Ukraine)		EN 61800-5-1 EN 60529 EN 61800-3 EN 63000 EN 60947-1 EN 60947-4 EN 61558-1 EN 50581	C311900	
UKCA (United Kingdom)		EN 61800-5-1 EN 60529 EN 61800-3 EN 63000 EN 61800-9-1 EN 61800-9-2	C352000	

Introduction
NORDAC PRO SK 500P
NORDAC PRO SK 500E
NORDAC LINK
NORDAC ON
NORDAC FLEX
NORDAC BASE
NORDAC START
Accessories

Type code

Frequency inverter

SK 300P-360-340-A

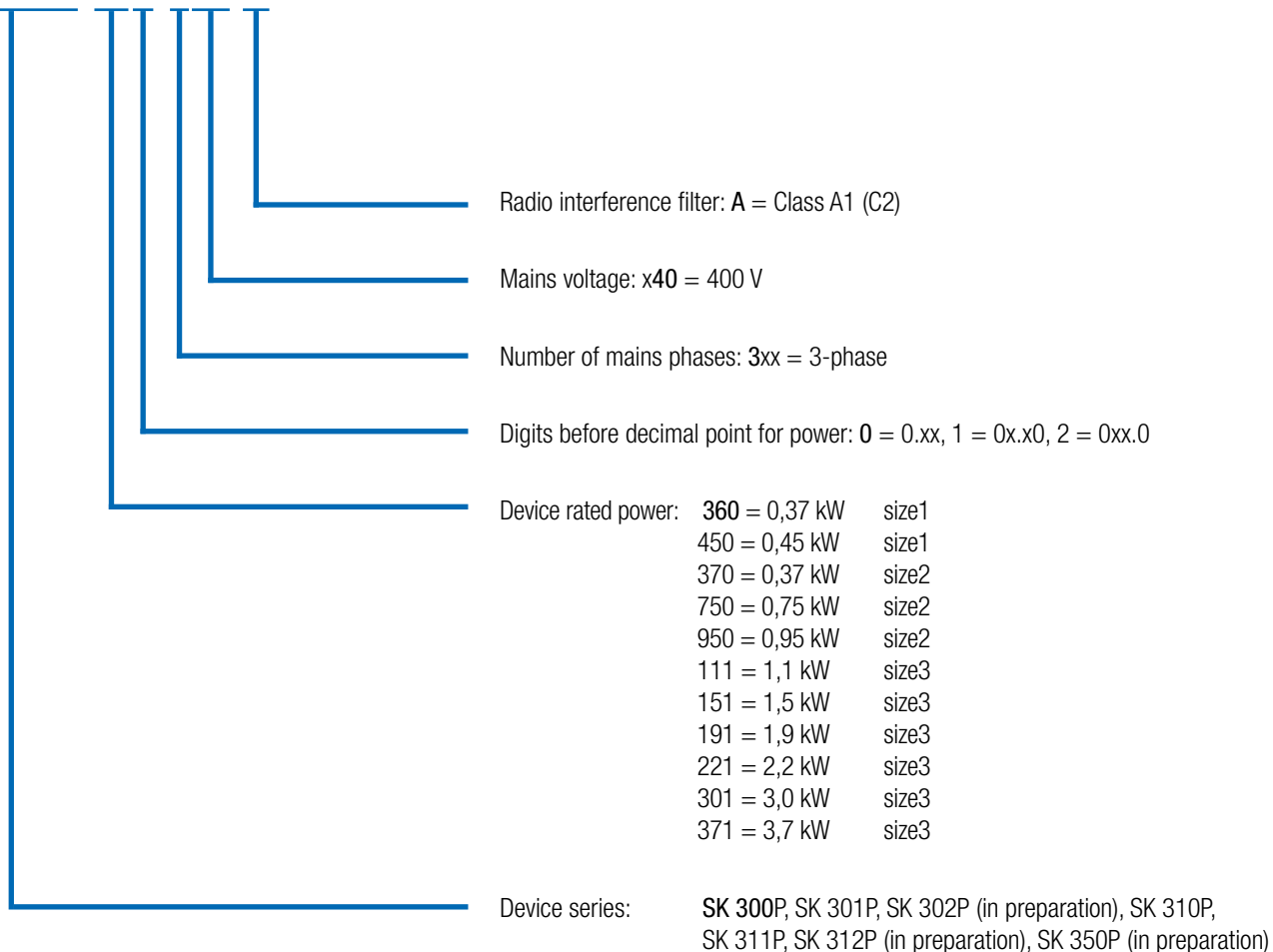

NORDAC ON, SK 300P series all versions at a glance

	NORDAC ON SK 30xP	NORDAC ON SK 30xP	NORDAC ON+ SK 31xP	NORDAC ON PURE SK 350P
Power	0.37 - 0.45 kW	0.37 - 3.7 kW	0.37 - 3.7 kW	0.37 - 1.5 kW
Size	1	2 - 3	2 - 3	2 - 3
Sensorless current vector control (ISD control)	●	●	●	●
Asynchronous motor operation (closed-loop and open-loop)	●	●	● ²	● ²
Synchronous motor operation (PMSM) (closed-loop and control without encoder)	○	○	●	●
Mountable on IE3 motor	●	●	○	○
Mountable on IE5+ motor	○	○	●	●
RS485/RS232 diagnostic interface via RJ12	●	●	●	●
4 switchable parameter sets	●	●	●	●
All normal drive functions	●	●	●	●
Parameters pre-set with standard values	●	●	●	●
Stator resistance measurement	●	●	●	●
Energy-saving function, optimised efficiency in partial load operation	●	●	●	●
Class C2 line filter, motor-mounted or up to 5 m motor cable for wall-mounting	●	●	●	●
Monitoring functions	●	●	●	●
Load monitor	●	●	●	●
POSICON	○	○	●	●
PLC functionality	●	●	●	●
Ethernet communication: EtherCAT, Ethernet IP, ProfiNet IO	●	●	●	●
External 24 V DC power supply for the control board	●	●	●	●
Brake management for mechanical Holding brake	○	●	●	●
Brake chopper (braking resistor optional)	○	●	●	●
"Safe Torque Off" and "Safe Stop" (STO, SS1-t) functions	○	●	●	○
Internal braking resistors	○	●	●	●

¹ With integrated optional module SK CU6-STO, connection via M12 plug connectors

² Wall mounting only

- Available as standard
- Optional
- Not available

	NORDAC ON SK 30xP	NORDAC ON SK 30xP	NORDAC ON+ SK 31xP	NORDAC ON PURE SK 350P	
Power	0.37 - 0.45 kW	0.37 - 3.7 kW	0.37 - 3.7 kW	0.37 - 1.5 kW	
Size	1	2 - 3	2 - 3	2 - 3	
Interfaces and connections	Mountable on IE3 motor	●	●	○	
	Mountable on IE5+ motor	○	○	●	
	DIN via M12 plug connector	4-2 ¹	4-4 ² -2 ²	4-4 ² -2 ²	○
	DOUT via M12 plug connector	0-2 ¹	2-0 ² -2 ²	2-0 ² -2 ²	○
	Mains input (3-phase 400 V) with integrated 24 V DC via plug connector	●	●	●	●
	Mains output / daisy chain (3~ 400 V) with integrated 24 V DC via plug connector	●	●	●	●
	Thermostats (PTC)	●	●	●	●
	RS485 encoder interface	○	○	●	●
	RS232 diagnostic interface				

¹ 2 digital IOs optionally parameterisable as DIN or DOUT

² Version SK 3x1P and higher has 4 DINs, 2 of which are optionally parameterisable as DIN or DOUT.

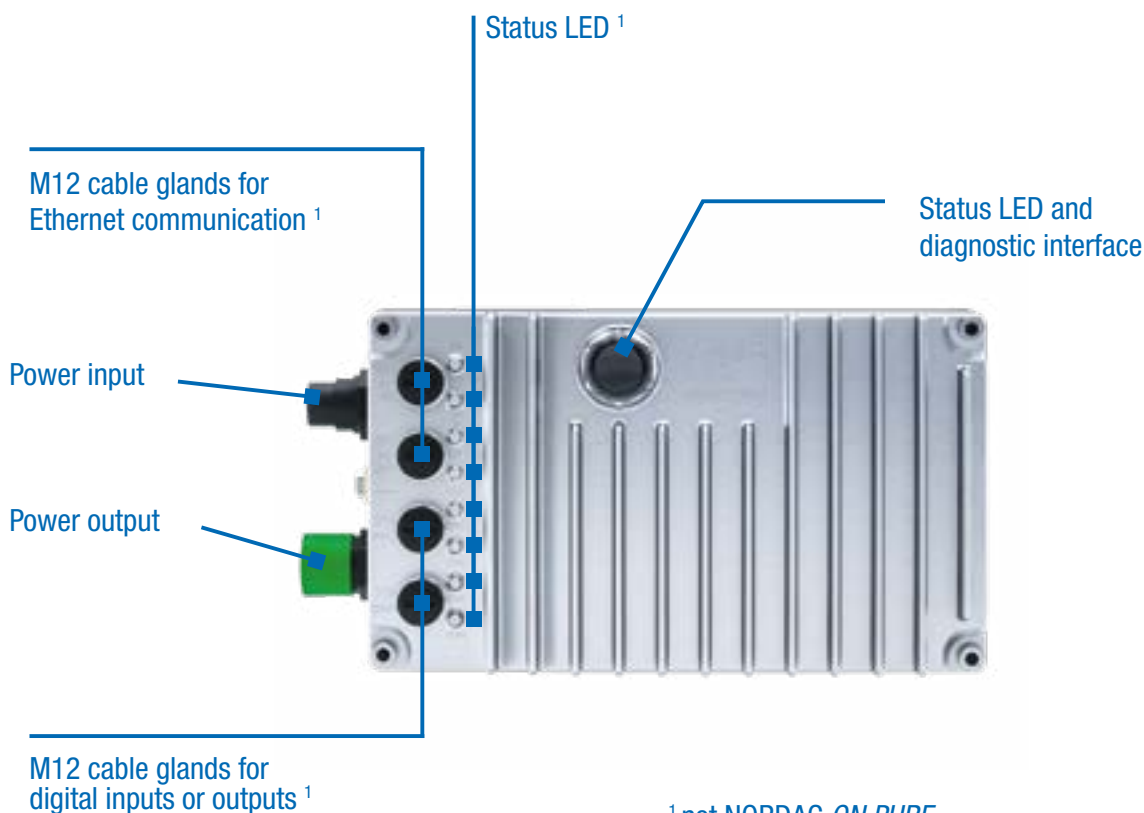

¹ not NORDAC ON PURE

Frequency inverter NORDAC ON

3~400 ... 480 V

Output frequency	0.0 ... 400.0 Hz	Protection class	IP55 , optional IP66 NORDAC ON PURE: only IP69 NEMA type 1 (higher NEMA classifications on request)
Pulse frequency	3.0 ... 16.0 kHz	Regulation and control	Sensorless current vector control (ISD), linear V/f characteristic curve
Typical overload capacity	150% for 60 s 200% for 5 s 250% for 1 s only asynchronous motors	Motor temperature monitoring	I ² t motor PTC / bimetallic switch
Frequency inverter efficiency	approx. 95%	Leakage current	< 30 mA
Ambient temperature	-30°C ... +40°C (S1) -30°C ... +50°C (S3, 70% ED)		

Frequency inverter	Nominal motor power		Nominal output current rms [A]	Mains voltage	Output voltage	Size
	400 V [kW]	480 V [hp]				
SK 300P-360-340-A	0,37	1/2	1,2	3~ 400 ... 480 V, -20 % / +10 %, 47 ... 63 Hz	3~ 0 up to mains voltage	1
SK 3xxP-370-340-A	0,37	1/2	1,2			2
SK 300P-450-340-A	0,45	3/5	1,5			1
SK 3xxP-750-340-A	0,75	1	2,2			2
SK 3xxP-950-340-A	0,95	1 1/4	2,7			2
SK 3xxP-111-340-A	1,1	1 1/2	3,0			3
SK 3xxP-151-340-A	1,5	2	3,8			3
SK 30xP-191-340-A	1,9	2 1/2	4,3			3
SK 3xxP-221-340-A	2,2	3	5,2			3
SK 3xxP-301-340-A	3,0	4	7,2			3
SK 31xP-371-340-A	3,7	5	8,1			3



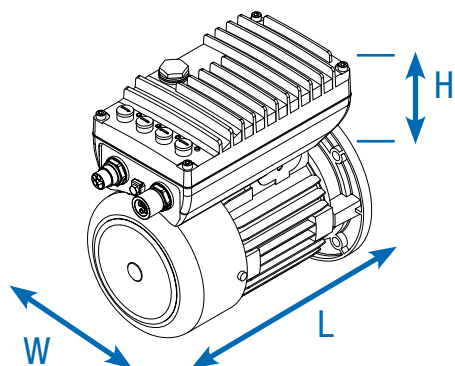

Frequency inverter	Motor	Weight [kg]	Dimensions for motor mounting excluding motor L x W x H [mm]	Size	
SK 30xP	-360-340-A bis -450-340-A	IE3 BG 63 - 71	1,5	230 x 121 x 79	1
	-370-340-A bis -950-340-A	IE3 BG 63 - 80	1,9	260 x 130 x 83	2
	-111-340-A bis -151-340-A	IE3 BG 80 - 90	3,3	296 x 160 x 104	3
	-191-340-A bis -371-340-A	IE3 BG 90 -100	3,5	296 x 160 x 123	3
SK 31xP	-370-340-A bis -950-340-A	IE5+ BG 71	1,9	251 x 130 x 97	2
	-111-340-A bis -151-340-A	IE5+ BG 90	3,4	285 x 160 x 124	3
	-221-340-A bis -371-340-A	IE5+ BG 90	3,6	304 x 160 x 144	3
SK 35xP	-370-340-A bis -750-340-A	IE5+ BG 71		277 x 133 x 122	2
	-111-340-A bis -151-340-A	IE5+ BG 90		307 x 160 x 146	3

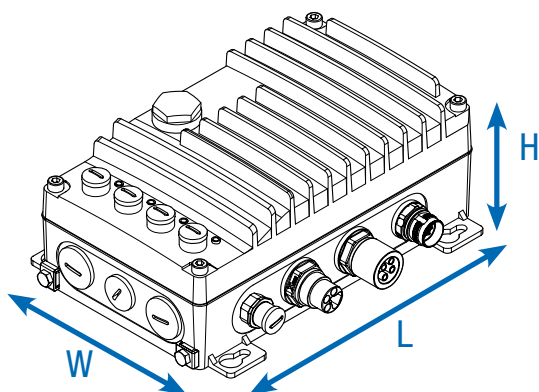

Frequency inverter	Weight [kg]	Dimensions for wall mounting L x W x H [mm]	Size	
-360-340-A bis -450-340-A	1,7	211 x 161 x 84	1	
SK 30xP/ SK 31xP	-370-340-A bis -950-340-A	2,1	244 x 171 x 99	2
	-111-340-A bis -151-340-A	3,5	272 x 201 x 117	3
	-191-340-A bis -371-340-A	3,7	272 x 201 x 137	3
SK 35xP	-370-340-A bis -750-340-A		260 x 184 x 111	2
	-111-340-A bis -151-340-A		290 x 214 x 134	3

NORDAC ON SK 30xP

Power 0,37 – 3,2 kW
 Mains voltage: 3 ~ 400 V
 Supply voltage: 24VDC extern
 Typical overload capacity: 150 % for 60 s, 200 % for 5 s,
 250 % for 1 s
 Ambient temperature: -30...+40° C (S1)
 Protection class: IP55/IP66



Motor	Size 1	Size 2	Size 3
63 LP/4 – 2.600 rpm	1.2 Nm – 0.31 kW	1.2 Nm – 0.31 kW ¹	
71 SP/4 – 2.600 rpm	1.6 Nm – 0.43 kW	1.6 Nm – 0.43 kW ¹	
71 LP/4 – 2.600 rpm		2.4 Nm – 0.65 kW	
80 SP/4 – 2.600 rpm		3.6 Nm – 0.95 kW	
80 LP/4 – 2.600 rpm			4.9 Nm – 1.3 kW
90 SP/4 – 2.600 rpm			7.1 Nm – 2.2 kW
90 LP/4 – 2.600 rpm			9.8 Nm – 2.6 kW
100 LP/4 – 2.600 rpm			11.8 Nm – 3.2 kW

¹Diese Frequenzumrichter–Motor-Kombinationen sind möglich, wenn Funktionen wie Bremsenansteuerung oder der Einbau der SK CU6-STO / interner Bremswiderstand nötig ist.

NORDAC ON PURE SK 35xP

Power: up to 1,5 kW
 Mains voltage: 3 ~ 400 V
 Supply voltage: 24VDC extern
 Typical overload capacity: 150 % for 60 s, 200 % for 5 s
 Ambient temperature: -30...+40° C (S1)
 Protection class: IP69K



Motor	Size 2	Size 3
IE5+ SK 71 N1/8 – 2.100 rpm	1.6 Nm – 0.35 kW	
IE5+ SK 71 N2/8 – 2.100 rpm	3.2 Nm – 0.70 kW	
IE5+ SK 90 N1/8 – 2.100 rpm		5.0 Nm – 1.10 kW
IE5+ SK 90 N2/8 – 2.100 rpm		6.8 Nm – 1.50 kW

NORDAC ON+ SK 31xP

Power: 0,37 – 3,7 kW
 Mains voltage: 3 ~ 400 V
 Supply voltage: 24VDC extern
 Typical overload capacity: 150 % for 60 s, 200 % for 5 s
 Ambient temperature: -30...+40° C (S1)
 Protection class: IP55/IP66

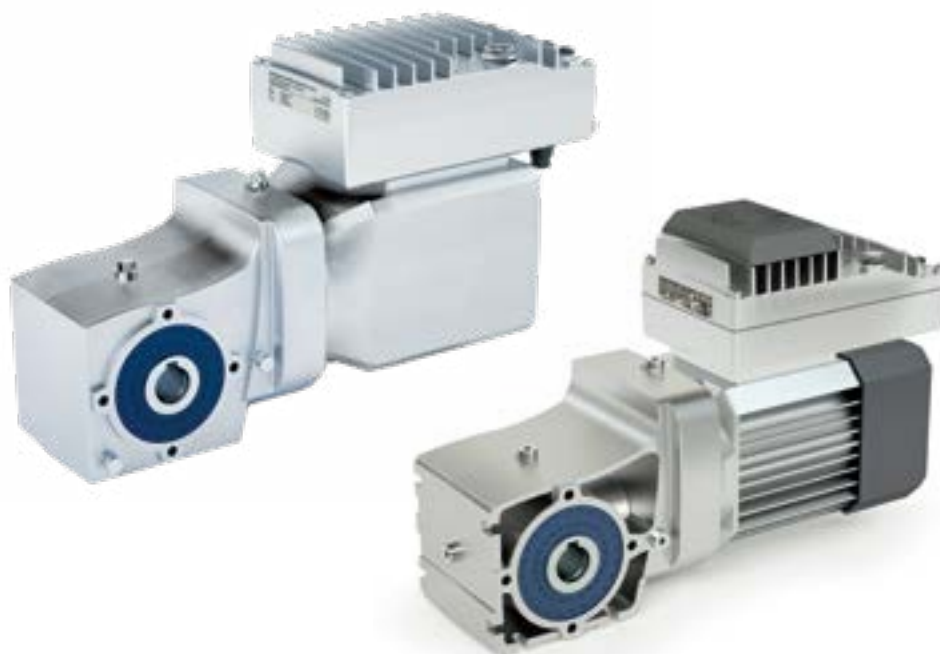

Motor non-ventilated	Size 2	Size3
IE5+ SK 71 N1/8 – 2.100 rpm	1.6 Nm – 0.35 kW	
IE5+ SK 71 N2/8 – 2.100 rpm	3.2 Nm – 0.70 kW	
IE5+ SK 90 N1/8 – 2.100 rpm		1.6 Nm – 0.35 kW
IE5+ SK 90 N2/8 – 2.100 rpm		3.2 Nm – 0.70 kW

Motor ventilated	Size 2	Size
IE5+ SK 71 F1/8 – 2.400 rpm	2.0 Nm – 0.50 kW	
IE5+ SK 71 F2/8 – 2.400 rpm	3.8 Nm – 0.95 kW	
IE5+ SK 90 F1/8 – 2.400 rpm		6.0 Nm – 1.50 kW
IE5+ SK 90 F2/8 – 2.400 rpm		8.8 Nm – 2.20 kW
IE5+ SK 90 F3/8 – 2.400 rpm		11.9 Nm – 3.00 kW
IE5+ SK 90 F4/8 – 2.400 rpm		14.7 Nm – 3.70 kW

NORDAC *ON* options

Functional Safety

NORDAC *ON* and NORDAC *ON+* frequency inverters in sizes 2 and 3 have the “Functional safety” option.

Available in the following devices:

SK 301P, SK 311P

Functions	IOs	Remarks
Functional safety: STO - PLe / SIL 3 SS1-t - PLd / SIL 2	2 safe DIN	Functional safety: 2-channel connection

Internal braking resistors

Internal braking resistors are intended for applications in which slight or only sporadic and brief braking is to be expected.

Internal braking resistors cannot be retrofitted and must therefore be taken into account in the order. For thermal reasons, the rated continuous output is limited to 25%.

	Frequency inverter	Wall mounting	Motor assembly	Resistance [Ω]	Continuous output ¹ P _D [W]	Power consumption ¹ E _{max} [kWs]	Size
SK 30xP	-370-340-A to -950-340-A	●	●	400	20	0.9	2
	-111-340-A to -371-340-A	●	●	300	40	1.3	3
SK 31xP	-370-340-A to -950-340-A	●	●	400	20	0.9	2
	-111-340-A to -371-340-A	●		300	40	1.3	3
	-111-340-A to -151-340-A		●	400	20	0.9	3
	-221-340-A to -371-340-A		●	200	40	2.0	3
SK 35xP	-370-340-A to -750-340-A	●	●	400	20	0.9	2
	-111-340-A to -151-340-A	●		300	40	1.3	3
	-111-340-A to -151-340-A		●	400	20	0.9	3

¹ Permissible continuous power of the braking resistor: 25% of the nominal power

² Once within 10 s,

Interfaces for operation, parameterisation and communication

Operation and parameterisation

Optional modules with up to 14 languages for displaying status and operational indicators, parameterisation and operation of the frequency inverter. In addition to variants for direct mounting on the device or installation in a control cabinet door, handheld versions are also available. See also Accessories starting on page 165

	Type Designation Part number	Description	Remarks
	ParameterBox SK PAR-5H 275 281 614	Control and parameterisation, LCD (illuminated), plain text display in 14 languages, direct control of up to five devices, memory for five device data sets, convenient control keypad, communication via RS485, including 1.5 m connection cable. Handheld, suitable for installation in a control cabinet door. IP54	Connection for data exchange with NORDCON <i>STUDIO</i> to a PC (USB 2.0), (standard "USB-C" connection cable required, e.g. material number: 275 292 100) Power supply, e.g. directly via frequency inverter or PC
	SimpleControlBox SK CSX-3H 275 281 013	Control and parameterisation, 4-digit 7-segment display, direct control of a device, convenient control keypad, including 2 m connection cable. Handheld, IP54	Electrical data: 4.5 ... 30 V DC / 1.3 W, Supply e.g. directly via the frequency inverter.
	Control and parameterisation software NORDCON	Software for control and parameterisation as well as support for commissioning and fault analysis of NORD electronic drive technology. Parameter names in 14 languages	Free download: www.nord.com
	Bluetooth-Stick NORDAC <i>ACCESS BT</i> SK TIE5-BT-STICK 275 900 120	Interface for wireless connection to a mobile terminal device (e.g. tablet or smartphone) via Bluetooth. The NORDCON <i>APP</i> , the NORDCON software for mobile terminal devices, enables smart operation and parameterisation as well as commissioning assistance and fault analysis of NORD electronic drive technology.	Available free of charge for Android and iOS 





Frequency inverter for decentralised applications

NORDAC *FLEX* SK 200E series



Master of adaptation

NORDAC FLEX, SK 200E series



[NORDAC FLEX](#)

Frequency inverters are now essential components of electrical drive technology. They are used for a wide range of automation tasks in almost all fields of application.

Universal

The NORDAC FLEX, the all-rounder among decentralised frequency inverters, has established itself in almost all areas of engineering and industry.

This is due not only to the wide range of available powers (up to 22 kW - which by no means is something that can be taken for granted in decentralised drive technology) but also to the wide selection of functions and the flexibility offered by its comprehensive range of accessories.

Economical

The series has been structured with various function levels in order to take efficiency and customers' application-specific requirements into consideration. In addition, we have arranged the series into two equipment groups which optimally cater for typical customer applications for conveyors, pumps and fans.

Energy-saving

Even, or especially for applications in which a frequency inverter is not strictly necessary from a technical point of view (constant speed with 50 Hz), the NORDAC FLEX beats every unregulated drive unit with its enormous energy-saving characteristics, particularly in partial load operation



Basic configuration

- Sensorless **current vector control** and **V/f characteristic curve**
- 4 switchable **parameter sets** for flexible use of parameter settings
- All common **drive functions** e.g. acceleration / braking on a ramp, PI controller
- **Parameters** with pre-set standard values
- **POSI CON** for relative and absolute positioning
- **Incremental encoder interface** for speed feedback
- **Stator resistance measurement**
- **PLC functionality** for drive-related functions
- Operation of **three-phase asynchronous motors (ASM)** and **permanent magnet synchronous motors (PMSM)**

Optional

- Interfaces for **8 field bus systems at present**
- **Various control options** (switch, potentiometer or control and parameterisation units)
- Versions with **functional safety** (Safe Stop)
- **IO modules** for additional analogue and digital inputs and outputs
- **System plug connectors** for power connection of mains and motor cables (industrial plug connectors) as well as for control and signal cables (M12 plug connectors)
- **ATEX versions** for operation in zone 22-3D

Pump/fan applications with the SK 2x0E

1~	230 V	0.25	-	0.55 kW
3~	230 V	0.25	-	11.0 kW
3~	400 V	0.55	-	22.0 kW

Typical requirements

- ▶ Speed setpoints/process signals via analogue input, e.g. pressure sensors
- ▶ Stand-alone operation of individual drive units or mobile systems, thanks to integrated control voltage
- ▶ No motor or brake control necessary



Conveyor applications with SK 2x5E (SK 2x0E, Size 4)

1~	115 V	0.25	-	0.75 kW
1~	230 V	0.25	-	1.1 kW
3~	230 V	0.25	-	4.0 kW (11.0 kW)
3~	400 V	0.55	-	7.5 kW (22.0 kW)

Typical requirements

- ▶ Separate voltage levels 400 V / 24 V, e.g. for separate start-up of bus system / control level and power
- ▶ Adjustable brake control with integrated rectifier
- ▶ No processing of analogue values required as bus control is frequently used

Basic configuration SK 2x0E series



4 digital inputs

e.g. for left/right enabling, fixed frequencies or parameter set switchover



2 digital outputs

e.g. for reporting errors or various limit values



1 or 2 analogue inputs

e.g. connection for speed setpoint or process signals



Integrated 24 V power supply

24 V control voltage for stand-alone operation

Basic configuration SK 2x5E series



4 digital inputs

e.g. for left/right enabling, fixed frequencies or parameter set switchover



1 digital output

e.g. for reporting errors or various limit values



Connection for external 24 V power supply

Separate voltage levels for power and control, e.g. for separate start-up or online availability when the power is switched off



Integrated brake rectifier

Application and release time optimally adjustable via parameter

If you are looking for a controlled drive unit

If you are looking for a drive unit with which your machine can perform specific functions.

We can supply the optimum device. A drive unit consisting of a combination of series production units that is perfectly tailored to your requirements. A drive unit which can be easily retrofitted with a wide range of accessories to adapt it to changed conditions.



If you have:

Limited space

- ▶ Restricted installation space in the machine

High performance requirements

- ▶ High-performance drive units
- ▶ High breakaway torques

A need for high-precision speed control

- ▶ Speed fluctuations are not permissible
- ▶ Perfect load take-up (lifting equipment) is required
- ▶ Compensation for fluctuating loads (conveyor belts/conveying equipment)

A need for high-precision positioning

- ▶ Master-slave synchronisation
- ▶ Movement to fixed positions (storage and retrieval machines)
- ▶ Movement to relative positions (endless belts in bottling plants)
- ▶ Movement of a drive unit to a changing position of a moving drive system (flying saw)

A need for high flexibility

- ▶ Short timeframe in case of service
- ▶ Frequent changes of use of your machine
- ▶ Existing motor and gear unit

A need for plug and play

- ▶ E.g. for large projects or series production machinery
- ▶ Replacement devices for 1:1 exchange in case of service

A need for sustainability

- ▶ Resource-saving operation
- ▶ Use of products with low levels of hazardous substances

Our solution:

Space-saving

- ▶ A compact device designed for the smallest possible overall dimensions
- ▶ Integrable optional modules (e.g. interfaces for field bus connection)
- ▶ Wall mounting kits for installation close to the motor



Powerful

- ▶ Unbeatable power range from 0.25 kW to 22.0 kW
- ▶ Optimised for continuous operation in 4 matching sizes
- ▶ Genuinely usable overload reserves of up to 200% of the rated power



Fast

- ▶ Comprehensive measuring methods for recording the actual electrical data as the basis for excellent control of the drive unit
- ▶ Integrated, precise and fast-acting current vector control for immediate adaptation to actual load conditions
- ▶ Integrated interface for connection of an incremental encoder to detect the actual motor speed (prerequisite for precise control)



Precise

- ▶ Integrated, precise, fast and completely autonomous positioning function (POSICON)
- ▶ Integrated interface for connection of an absolute encoder to detect the actual position



Adaptable

- ▶ Integrated DIP switches for basic configuration without modification of the software
- ▶ Comprehensive selection of plug connectors for control and power cable connections
- ▶ Easily accessible exchangeable data carrier (EEPROM) for simple exchange of parameter settings between identical devices
- ▶ Devices can also be supplied individually



Configurable

- ▶ Mounted on the geared motor
- ▶ Equipped with the necessary accessories (braking resistor, bus interface, encoders, etc.)
- ▶ Pre-parameterised for the specified drive application
- ▶ Equipped with the necessary system plug connectors









Environmentally friendly

- ▶ Low-loss use of energy
- ▶ Energy-saving function to match the power output to the actual demand in partial load operation
- ▶ Consideration of environmental protection even during manufacture (e.g. RoHS)



Standards and approvals

All devices of the entire series comply with the standards and directives listed below.

Approval	Directive	Applied standards	Certificates	Code
CE (European Union)	Low Voltage Directive 2014/35/EU	EN 61800-5-1	C310700	
	EMC 2014/30/EU	EN 60529	C310401	
	RoHS 2011/65/EU	EN 61800-3 EN 63000		
	Delegated directive (EU) 2015/863	EN 61800-9-1 EN 61800-9-2		
	Ecodesign 2009/125/EG			
	Regulation (EU) 2019/1781 Ecodesign			
UL (USA)		UL 61800-5-1	E171342	
CSA (Canada)		C22.2 No. 274-13	E171342	
RCM (Australia)	F2018L00028	EN 61800-3	133520966	
EAC (Eurasia)	TR CU 004/2011, TR CU 020/2011	IEC 61800-5-1 IEC 61800-3	EAЭC N RU Д-DE. HB27.B.02727/20	
UkrSEPRO (Ukraine)		EN 61800-5-1 EN 60529 EN 61800-3 EN 63000 EN 60947-1 EN 60947-4 EN 61558-1 EN 50581	C311900	
UKCA (United Kingdom)		EN 61800-5-1 EN 60529 EN 61800-3 EN 63000 EN 61800-9-1 EN 61800-9-2	C350700, C350401	

Devices which are configured and approved for use in explosion hazard environments comply with the following directives and standards.

Approval	Directive	Applied standards	Certificates	Code
CE (European Union)	LATEX	2014/34/EU	EN 60079-0	
	Low Voltage Directive	2014/35/EU	EN 60079-31	
	EMC	2014/30/EU	EN 61800-5-1 EN 60529	
	RoHS	2011/65/EU	EN 61800-3	
	Delegated directive (EU)	2015/863	EN 63000 EN 61800-9-1 EN 61800-9-2	
	Ecodesign	2009/125/EG		
	Regulation (EU)	2019/1781		
	Ecodesign			

Type code

Frequency inverter - Basic device

SK 205E-370-323-A (-C) (xxx)

Special Version

IP protection class Standard = IP55, C = IP66

Radio interference filter: 0 = without, A = Class A1 (C2)

Mains voltage: x12 = 115 V, x23 = 230 V, x40 = 400 V

Number of mains phases: 1xx = 1-phase, 3xx = 3-phase

Device rated power: 250 = 0.25 kW, 370 = 0.37 kW,
...222 = 22.0 kW

Frequency inverter series: SK 200E, **SK 205E**, SK 210E, SK 215E,
SK 220E, SK 225E, SK 230E, SK 235E

(...) Options, only implemented if required.

Frequency inverter - Connection unit

SK TI4-1-205-1 (-C-EX)

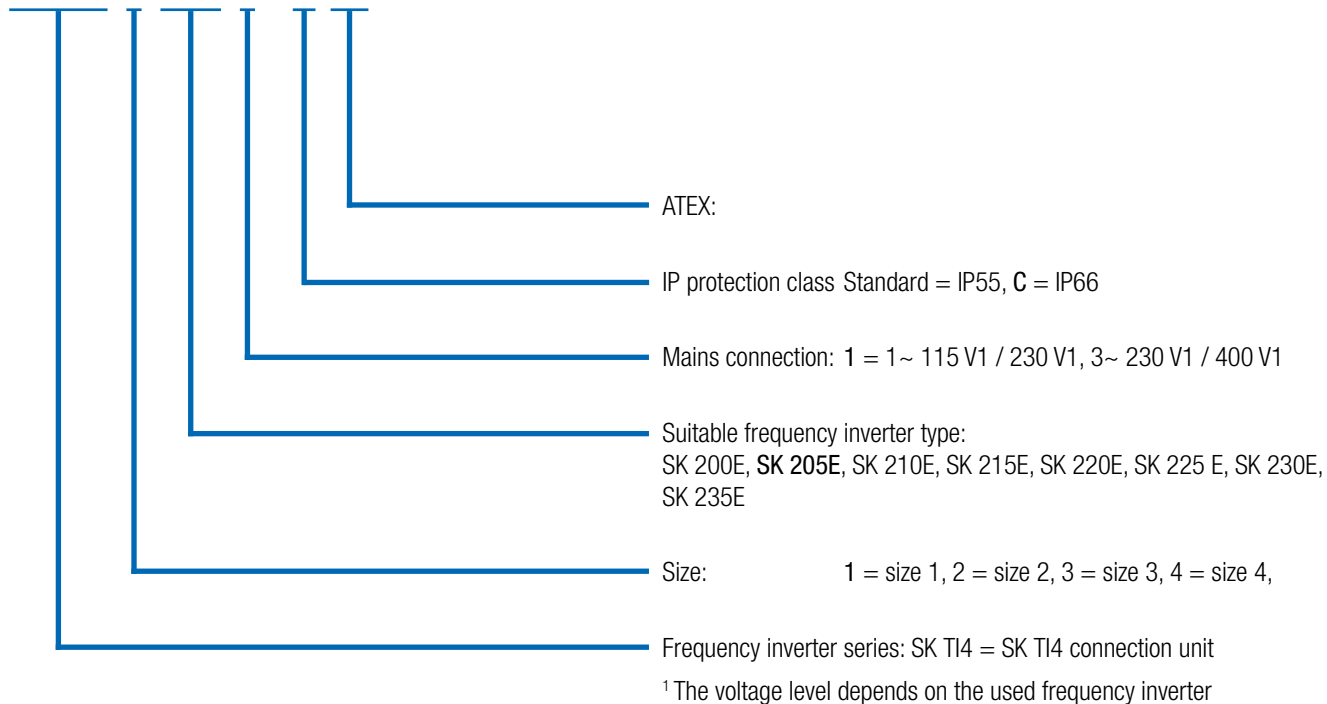

Versatile and sustainable

The frequency inverter with „servo genes“

CANopen



Standard encoder interfaces

The frequency inverters' speed control is extremely precise thanks to sophisticated and fast measuring methods and calculation algorithms in combination with integrated high-precision current vector control.

However, there are applications where precision of a thousandth of a motor revolution and very high dynamics (maximum acceleration, cyclic operation, synchronous rotation relative to other drive units) are needed. In such cases, precise feedback from the mechanical momentary values of the motor or the drive unit is required. This feedback is provided by **incremental encoders**, which are normally mounted on the motor shaft and provide information about its actual position. These values enable the motor to be precisely controlled by the frequency inverter so that even with large load fluctuations an asynchronous motor can be operated with a performance similar to that of a servo motor.

Absolute encoders round off the concept so that high-precision drive applications such as

- ▶ Synchronisation of multiple drive units
- ▶ Dynamic synchronisation of a drive unit to a different drive unit (flying saw)
- ▶ Relative positioning tasks (cyclical drives)
- ▶ Absolute positioning tasks (automatic warehouse equipment / high-bay storage, lifting equipment with defined positions)

are possible.

Each frequency inverter is equipped with a corresponding interface.

- ▶ HTL incremental encoder interface (connection via 2 digital inputs) - primarily for speed control
- ▶ CANopen absolute encoder interface (connection via system bus) - primarily for positioning

Available in all size

Modern automation systems



Power
(115 V / 230 V / 400 V)

AS-Interface
including 24 V supply SK 2xxE

Modern automation systems have a wide range of requirements, so that a suitable bus system and drive components must be selected in order to ensure efficient implementation.

For the lower field level, the AS-Interface is a cost-effective solution which enables the networking of binary sensors and actuators. With NORDAC *FLEX*, special versions which provide an appropriate solution by means of an **AS-Interface**, are available for this price-sensitive area.

The supply voltage (power) is connected separately via the corresponding terminals. Depending on the version of the device, the control voltage of the frequency inverter is generated either via an integrated power supply unit or is supplied separately via the yellow AS-Interface cable. This eliminates the need for an additional AUX cable (black). The type of addressing possible (standard or A/B slaves) also depends on the version of the device.

Device SK ...	220E/230E	225E/235E
Slave profile	S-7.A.	S-7.0.
Slave type	A/B-Slave	Standard
Control voltage	Internal power supply	Yellow AS-I cable
Inputs/Outputs	4/4	4/4
Configuration via DIP switch	●	●
Configuration via parameters	●	●

ATEX-compliant drive systems, zone 22 3D

Size 1-3 devices can be modified for operation in explosive atmospheres.

This allows the operation of the frequency inverter directly in a hazardous area (ATEX 22-3D). The advantages are obvious:

- ▶ Compact drive unit
- ▶ No complex protective devices
- ▶ No motor cables
- ▶ Optimum EMC
- ▶ Permissible characteristic curves 50 Hz / 87 Hz
- ▶ Control range up to 100 Hz or 3000 rpm

Depending on the area of application (conductive or non-conductive dust) the modification includes, among others, replacement of the transparent diagnostic caps with a version made of aluminium and glass.

It must be noted that operation of the device within the hazard area is only permitted with integrable modules (SK CU4 modules, internal brake resistors) or specially approved accessories (ATEX potentiometer „SK ATX-POT“).

There are exceptions for SK TU4 modules, which are described in detail in the manual for the device. Other accessories (e.g. external brake resistors, plug connectors) are not approved for use within a hazardous area.



Approval

- ▶ According to 2014/34/EU
- ▶ ATEX Zone 22 - 3D
 - ▶ Version for non-conducting dust: IP55
 - ▶ Version for conducting dust: IP66

Available in all size 1-3 devices



The entire team

All device versions at a glance

	SK 200E	SK 210E	SK 220E	SK 230E	SK 205E	SK 215E	SK 225E	SK 235E
	Size 1-4, 0.25 - 22.0 kW				Size 1-3, 0.25 - 7.5 kW			
Motor and wall mounting possible ¹	●	●	●	●	●	●	●	●
Energy bus - loop-through of mains supply cables ²	●	●	●	●	●	●	●	●
Communication bus for various devices ²	●	●	●	●	●	●	●	●
Sensorless current vector control (ISD control)	●	●	●	●	●	●	●	●
Brake chopper (brake resistor optional)	●	●	●	●	●	●	●	●
RS-232 diagnostic interface	●	●	●	●	●	●	●	●
4 switchable parameter sets	●	●	●	●	●	●	●	●
Parameters pre-set with standard values	●	●	●	●	●	●	●	●
Automatic determination of motor data	●	●	●	●	●	●	●	●
Energy-saving function, optimised efficiency in partial load operation	●	●	●	●	●	●	●	●
Integrated EMC line filter according to EN 61800-3, Category C2 up to 5 m motor cable and for motor assembly	●	●	●	●	●	●	●	●
Extensive monitoring functions	●	●	●	●	●	●	●	●
Load monitor	●	●	●	●	●	●	●	●
PI controller	●	●	●	●	●	●	●	●
Process controller / compensator control	●	●	●	●	●	●	●	●
Plug-in memory module (EEPROM)	●	●	●	●	●	●	●	●
Incremental encoder evaluation (speed control)	●	●	●	●	●	●	●	●
POSICON positioning control	●	●	●	●	●	●	●	●
PLC functionality	●	●	●	●	●	●	●	●
Synchronous motor operation (PMSM)	●	●	●	●	●	●	●	●
Modification for operation in an IT network by means of jumpers	●	●	●	●	●	●	●	●
All common field bus systems	●	●	●	●	●	●	●	●
Brake management for mechanical holding brake	● ³	● ³	● ³	● ³	●	●	●	●
Lifting gear functionality	●	●	●	● ³	●	●	●	●
Safe Stop function (STO, SS1)	○	●	○	●	○	●	○	●
AS-Interface on board	○	○	●	●	○	○	●	●
Evacuation run	○ ³	○ ³	○ ³	○ ³	●	●	●	●
Internal 24 V power supply unit to supply the control board	●	●	●	●	●	●	●	●
External 24 V power supply for the control board	● ⁴	● ⁴	● ⁴	● ⁴	●	●	●	●
Internal / external braking resistors	●	●	●	●	●	●	●	●
Switch and potentiometer versions	●	●	●	●	●	●	●	●
Plug connectors for connection of control, motor and mains cables	●	●	●	●	●	●	●	●

¹ Wall mounting: wall mounting kit required
 Motor mounting: an adapter for connection to the motor terminal box may be necessary.

² Direct connection to the terminal bar or via system plug connectors

³ Size 4: standard

⁴ Size 1 -3: no, Size 4: optional

● Available as standard
 ● Optional
 ○ Not available

The senses

Control connections on the frequency inverter

	SK 200E	SK 210E	SK 220E	SK 230E	SK 200E	SK 210E	SK 220E	SK 230E	SK 205E	SK 215E	SK 225E	SK 235E	
	Size 1-3, 0.25 - 7.5 kW				Size 4, 11 - 22.0 kW				Size 1-3, 0.25 - 7.5 kW				
Control terminals	Number of digital inputs (DIN)	4	3	4	3	4	3	4	3	4	3	4	3
	Fail-safe digital input	○	●	○	●	○	●	○	●	○	●	○	●
	Number of digital outputs (DOUT)	2	2	2	2	2	2	2	2	1	1	1	1
	Number of analogue inputs (AIN) ¹	2	2	1	1	2	2	2	2	○	○	○	○
	Integrated brake rectifier	○	○	○	○	●	●	●	●	●	●	●	●
	Temperature sensor (PTC)	●	●	●	●	●	●	●	●	●	●	●	●
Encoder interfaces	HTL	●	●	●	●	●	●	●	●	●	●	●	●
	CANopen ^{®2}	●	●	●	●	●	●	●	●	●	●	●	●
Communication	RS 485 / RS232	●	●	●	●	●	●	●	●	●	●	●	●
	AS-I	○	○	●	●	○	○	●	●	○	○	●	●

¹ 0(2) - 10 V, 0(4) - 20 mA
² via system bus

Note

Control terminals can be supplemented by optional modules (IOs, brake management).

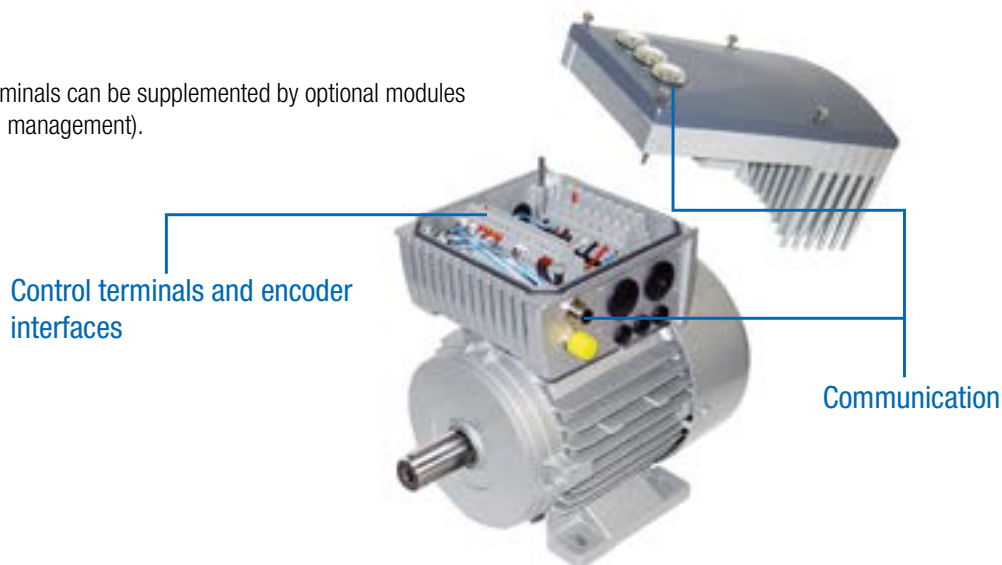

Configuration and monitoring

Integrated aids for safe operation

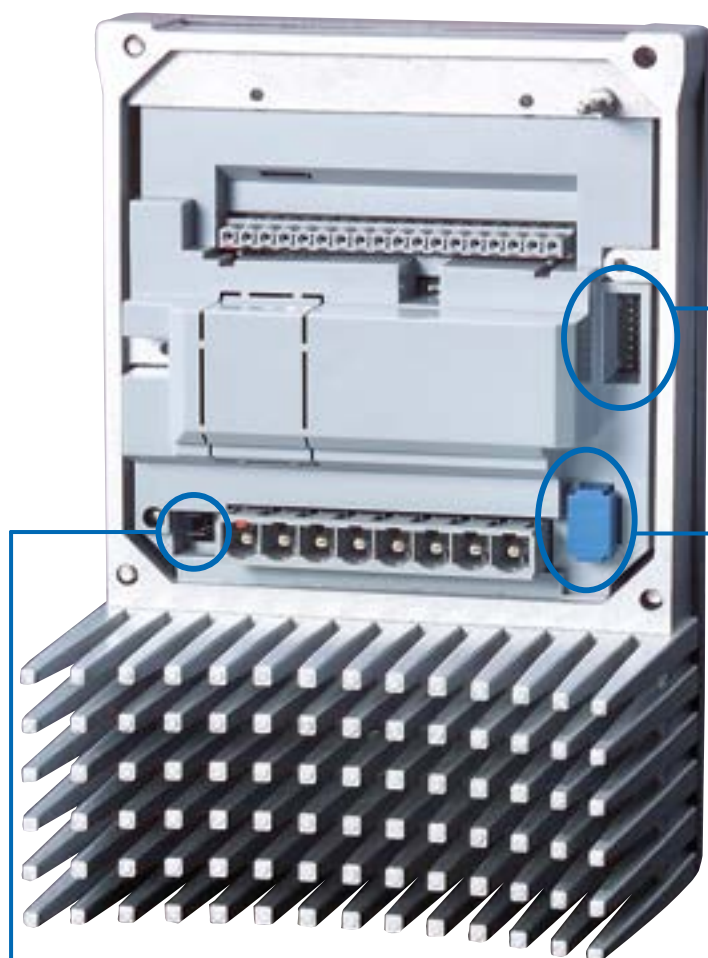

Commissioning with a screwdriver

Various basic functions can be simply set via easily accessible DIP switches so that commissioning is possible without parameterisation software. Even when an EEPROM is plugged in, the DIP switch settings have priority over the relevant parameters.



Plug-in EEPROM

The frequency inverter is equipped with two EEPROMs for saving the individual parameter settings of the device. One EEPROM is integrated into the device and another EEPROM can be plugged in and is easily accessible. All parameter settings are managed by the internal EEPROM. The data is mirrored to the external EEPROM. Because of the easy access, data sets can be exchanged between identical drive units via the plug-in EEPROM. Via an optional parameterisation adapter (SK EPG-3H) devices can be parameterised „in the laboratory“ so that only the plug-in EEPROM needs to be transferred between the system and the „laboratory“.

Jumpers for mains adaptation

It is possible to adapt the frequency inverter for operation in an IT network by plugging in a jumper. However, this adaptation has a negative effect on the emission of electromagnetic interference. Compliance with the specified degree of radio interference suppression can no longer be guaranteed in this case.

Status and diagnostic cockpit

Depending on the type of device, various aids for monitoring the device or for diagnostics in case of faults are located behind 3 transparent cover caps. In addition, there are further elements (e.g. DIP switches or similar) which are useful for screwdriver-assisted commissioning.



Example: SK 2x0E

SK 2x0E in Sizes 1-3

(Size 4 as for SK 2x5E)

1 Diagnostic interface, RS-232 and RS-485

RJ12 interface for connection of a diagnostic and parameterisation tool (e.g. PC with NORDCON software, ParameterBox). Analysis, diagnostics, parameterisation and monitoring of the drive unit via software is possible during commissioning or service.

2 DIP switches for analogue inputs

The integrated analogue inputs of the device can be configured to the signal form of setpoint values (current or voltage) via the DIP switches.

3 Status LED for frequency inverter and system bus

In addition to status and readiness indicators, the current overload level, warnings and error messages are indicated in coded form by the LEDs

SK 2x5E and SK 2x0E in Size 4

1 Diagnostic interface, RS-232 and RS-485

RJ12 interface for connection of a diagnostic and parameterisation tool (e.g. PC with NORDCON software, ParameterBox). Analysis, diagnostics, parameterisation and monitoring of the drive unit via software is possible during commissioning or service.

2 Status and diagnostic LEDs

In addition to the operating status of the system bus, various signal statuses (e.g. of the digital IOs) can be read out here.

3 Potentiometer and status LEDs

The two potentiometers are used for the fixed setting of various dynamic factors (setpoint frequency, frequency band, acceleration time). The two diagnostic LEDs indicate the operating statuses and error messages of the device or the AS-Interface (if present).

NORDAC FLEX frequency inverter

1~ 110 ... 120 V and 1/3~ 200 ... 240 V

Output frequency	0.0 ... 400.0 Hz	Protection class	IP55, optionally IP66, NEMA type1 (higher NEMA classifications on request)
Pulse frequency	3.0 ... 16.0 kHz	Regulation and control	Sensorless current vector control (ISD), linear V/f characteristic curve
Typical overload capacity	150 % for 60 s, 200 % for 3.5 s	Motor temperature monitoring	I ² t Motor PTC / bi-metal switch
Energy efficiency class	IE2	Leakage current	<40 mA for standard configuration of integrated line filter <20 mA for configuration for "operation on IT network"
Efficiency	> 95 %		
Ambient temperature	-25 °C ... +50 °C (depending on type of operation)		

Frequency inverters SK 2xxE ...	SK 2x0E	SK 2x5E	Nominal motor power		Nominal output current rms [A]	Mains voltage	Output voltage
			230 V [kW]	240 V [hp]			
-250-112-0 (-C)	○	●	0.25	1/3	1.7	1~ 110 ... 120 V, +/- 10 %, 47 ... 63 Hz	3~ 0 up to double the mains voltage
-370-112-0 (-C)	○	●	0.37	1/2	2.2		
-550-112-0 (-C)	○	●	0.55	3/4	3.0		
-750-112-0 (-C)	○	●	0.75	1	4.0		

Frequency inverters SK 2xxE ...	SK 2x0E	SK 2x5E	Nominal motor power		Nominal output current rms [A]	Mains voltage	Output voltage
			230 V [kW]	240 V [hp]			
-250-123-A (-C)	●	●	0.25	1/3	1.7	1~ 200 ... 240 V +/-10 % 47 ... 63 Hz	3 AC 0 – 200 ... 240 V
-370-123-A (-C)	●	●	0.37	1/2	2.2		
-550-123-A (-C)	●	●	0.55	3/4	3.0		
-750-123-A (-C)	○	●	0.75	1	4.0		
-111-123-A (-C)	○	●	1.1	1 1/2	5.5		

Frequency inverters SK 2xxE ...	SK 2x0E	SK 2x5E	Nominal motor power		Nominal output current rms [A]	Mains voltage	Output voltage
			230 V [kW]	240 V [hp]			
-250-323-A (-C)	●	●	0.25	1/3	1.7	3~ 200 ... 240 V, +/- 10 %, 47 ... 63 Hz	3~ 0 up to mains voltage
-370-323-A (-C)	●	●	0.37	1/2	2.2		
-550-323-A (-C)	●	●	0.55	3/4	3.0		
-750-323-A (-C)	●	●	0.75	1	4.0		
-111-323-A (-C)	●	●	1.1	1 1/2	5.5		
-151-323-A (-C)	●	●	1.5	2	7.0		
-221-323-A (-C)	●	●	2.2	3	9.5		
-301-323-A (-C)	●	●	3.0	4	12.5		
-401-323-A (-C)	●	●	4.0	5	16.0		
-551-323-A (-C)	●	○	5.5	7 1/2	23.0		
-751-323-A (-C)	●	○	7.5	10	29.0		
-112-323-A (-C)	●	○	11.0	15	40.0		

- Available as standard
- Not available

IP66 measures

- ▶ Coated aluminium components
- ▶ Coated circuit boards
- ▶ Low-pressure test
- ▶ Diaphragm valve

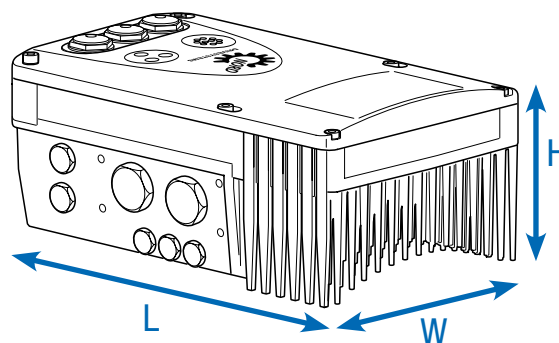

Frequency inverters SK 2xxE ...	SK 2x0E	SK 2x5E	Weight [kg]	(Overall) dimensions L x W x H [mm]	Size
-250-112-0 (-C)	○	●	3.0	236 x 156 x 127	1
-370-112-0 (-C)	○	●	3.0	236 x 156 x 127	1
-550-112-0 (-C)	○	●	4.1	266 x 176 x 134	2
-750-112-0 (-C)	○	●	4.1	266 x 176 x 134	2

Frequency inverters SK 2xxE ...	SK 2x0E	SK 2x5E	Weight [kg]	(Overall) dimensions L x W x H [mm]	Size
-250-123-A (-C)	●	●	3.0	236 x 156 x 127	1
-370-123-A (-C)	●	●	3.0	236 x 156 x 127	1
-550-123-A (-C)	●	●	3.0	236 x 156 x 127	1
-750-123-A (-C)	○	●	4.1	266 x 176 x 134	2
-111-123-A (-C)	○	●	4.1	266 x 176 x 134	2

Frequency inverters SK 2xxE ...	SK 2x0E	SK 2x5E	Weight [kg]	(Overall) dimensions L x W x H [mm]	Size
-250-323-A (-C)	●	●	3.0	236 x 156 x 127	1
-370-323-A (-C)	●	●	3.0	236 x 156 x 127	1
-550-323-A (-C)	●	●	3.0	236 x 156 x 127	1
-750-323-A (-C)	●	●	3.0	236 x 156 x 127	1
-111-323-A (-C)	●	●	3.0	236 x 156 x 127	1
-151-323-A (-C)	●	●	4.1	266 x 176 x 134	2
-221-323-A (-C)	●	●	4.1	266 x 176 x 134	2
-301-323-A (-C)	●	●	6.9	330 x 218 x 144	3
-401-323-A (-C)	●	●	6.9	330 x 218 x 144	3
-551-323-A (-C)	●	○	17.0	480 x 305 x 160	4
-751-323-A (-C)	●	○	17.0	480 x 305 x 160	4
-112-323-A (-C)	●	○	17.0	480 x 305 x 160	4

- Available as standard
- Not available

NORDAC *FLEX* frequency inverter

3~ 380 ... 500 V

Output frequency	0.0 ... 400.0 Hz	Protection class	IP55, optionally IP66, NEMA type1 (higher NEMA classifications on request)
Pulse frequency	3.0 ... 16.0 kHz	Regulation and control	Sensorless current vector control (ISD), linear V/f characteristic curve
Typical overload capacity	150 % for 60 s, 200 % for 3.5 s	Motor temperature monitoring	I ² t Motor PTC / bi-metal switch
Efficiency	> 95 %	Leakage current	<40 mA for standard configuration of integrated line filter <20 mA for configuration for "operation on IT network"
Ambient temperature	-25 °C ... +50 °C (depending on type of operation)		

Frequency inverters SK 2xxE ...	SK 2x0E	SK 2x5E	Nominal motor power		Nominal output current rms [A]	Mains voltage	Output voltage
			400 V [kW]	480 V [hp]			
-550-340-A	●	●	0.55	3/4	1.7	3~ 380 ... 500 V, -20 % / +10 %, 47 ... 63 Hz	3~ 0 up to mains voltage
-750-340-A	●	●	0.75	1	2.3		
-111-340-A	●	●	1.1	1 1/2	3.1		
-151-340-A	●	●	1.5	2	4.0		
-221-340-A	●	●	2.2	3	5.5		
-301-340-A	●	●	3.0	4	7.5		
-401-340-A	●	●	4.0	5	9.5		
-551-340-A	●	●	5.5	7 1/2	12.5		
-751-340-A	●	●	7.5	10	16.0		
-112-340-A	●	○	11.0	15	23.0		
-152-340-A	●	○	15.0	20	32.0		
-182-340-A	●	○	18.5	25	40.0		
-222-340-A	●	○	22.0	30	46.0		

- Available as standard
- Not available

IP66 measures

- ▶ Coated aluminium components
- ▶ Coated circuit boards
- ▶ Low-pressure test
- ▶ Diaphragm valve

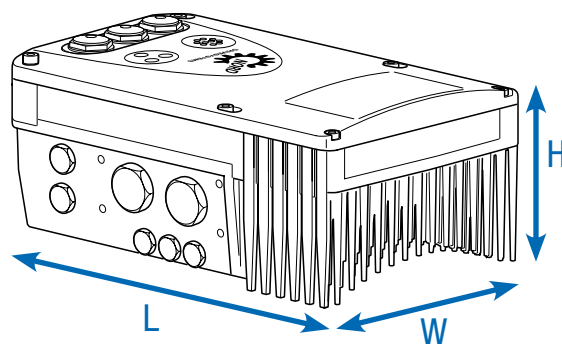

Frequency inverters SK 2xxE ...	SK 2x0E	SK 2x5E	Weight [kg]	(Overall) dimensions L x W x H [mm]	Size
-550-340-A	●	●	3.0	236 x 156 x 127	1
-750-340-A	●	●	3.0	236 x 156 x 127	1
-111-340-A	●	●	3.0	236 x 156 x 127	1
-151-340-A	●	●	3.0	236 x 156 x 127	1
-221-340-A	●	●	3.0	236 x 156 x 127	1
-301-340-A	●	●	4.1	266 x 176 x 134	2
-401-340-A	●	●	4.1	266 x 176 x 134	2
-551-340-A	●	●	6.9	330 x 218 x 144	3
-751-340-A	●	●	6.9	330 x 218 x 144	3
-112-340-A	●	○	17.0	480 x 305 x 160	4
-152-340-A	●	○	17.0	480 x 305 x 160	4
-182-340-A	●	○	17.0	480 x 305 x 160	4
-222-340-A	●	○	17.0	480 x 305 x 160	4

- Available as standard
- Not available

We bring together what belongs together

The NORDAC *FLEX*

consists of 2 elements – the actual frequency inverter and a suitable connection unit. The connection unit contains all device-specific connection terminals and a space for the supplement of an optional SK CU4-... module (internal control terminal).



The NORDAC *FLEX* is usually directly mounted on a motor.

The NORDAC *FLEX* can be combined with motors from various power and efficiency classes. Depending on the motor with which the frequency inverter is combined, the mounting on the terminal box base of the motor may require an additional mounting adapter.



Adjustments for motor mounting

The terminal box fixations partially differ between the single motor sizes. It may therefore necessary for the device structure to use adapters.

To ensure the device's maximum IPxx protection class for the entire unit, all elements of the drive unit (e.g.

motor) must comply with the same protection class. NORDAC *FLEX* can also be combined with IE5+ motors from NORD. The frequency inverter output matches the motor power.

Size NORD motors	Attachment SK 2xxE BG 1	Attachment SK 2xxE BG 2	Attachment SK 2xxE BG 3	Attachment SK 2xxE BG 4
63 – 71	With adapter kit I	With adapter kit I	nicht möglich	Not possible
80 – 112	Direct mounting	Direct mounting	With adapter kit II	Not possible
132	Not possible	Not possible	Direct mounting	With adapter kit III
160-180	Not possible	Not possible	Not possible	Direct mounting

Synchronous motor up to IE5+

NORD Synchronous motor (IE5+)	Frequency inverter	Attachment
71F1/8	SK 2xxE-550-340A	107 352 00
71F2/8	SK 2xxE-111-340A	107 352 00
71F3/8	SK 2xxE-151-340A	107 352 00
71F4/8	SK 2xxE-221-340A	107 352 00
90F1/8	SK 2xxE-151-340A	107 352 00
90F2/8	SK 2xxE-221-340A	107 352 00
90F3/8	SK 2xxE-301-340A	107 352 00
90F4/8	SK 2xxE-401-340A	107 352 00

Varied installation possibilities

Motor Assembly

The frequency inverter can be mounted directly on the terminal box of the (geared) motor, thus forming a perfect unit consisting of the drive and the control technology. This motor-mounted format makes full use of its unbeatable advantages: compact overall dimensions of the drive unit, practically immediate readiness for use after connection to the mains supply thanks to the pre-configuration of the drive unit at the factory, optimum EMC due to short cable lengths - or elimination of a motor cable.

Wall mounting

As an alternative to motor mounting, the device can be mounted close to the motor with the aid of an optional wall mounting kit.

You can select from different versions depending on the prevalent ambient conditions.

1. Standard version SK TIE4-WMK-1-K (-2-K or -3)

Note: If the frequency inverter is wall mounted, the cooling air flow from the motor is not present. This can ultimately result in power restrictions (derating) for the frequency inverter.

2. Version with fan SK TIE4-WMK-L-1 (or -L-2)

This version differs from the standard version due to an extra fan. The fan ensures a continuous flow of cooling air over the frequency inverter. This avoids derating due to wall mounting.

As standard, Size 4 frequency inverters are equipped with fans. A corresponding wall mounting kit is therefore not necessary and is not available.

3. ATEX version SK TIE4-WMK-1-EX (up to -2-EX)

This version is functionally comparable to the standard version, however it is suitable for use in explosion hazard environments (ATEX Zone 22 3D).

Designation	Material No.	Frequency inverters ¹ for size FI
SK TIE4-WMK-1-K	275 274 004	BG 1, 2
SK TIE4-WMK-2-K	275 274 015	BG 3
SK TIE4-WMK-L-1	275 274 005	BG 1, 2
SK TIE4-WMK-L-1-C	275 274 016	BG 1, 2
SK TIE4-WMK-L-2	275 274 006	BG 3
SK TIE4-WMK-1-EX	275 175 053	BG 1, 2
SK TIE4-WMK-2-EX	275 175 054	BG 3
SK TIE4-WMK-3	275 274 003	BG 4
SK TIE4-WMK-TU ²	275 274 002	Typ: SK TU4-

¹ Mounting of the WMK on the connection unit of the frequency inverter

² Mounting of the WMK on the connection unit of the technology unit

Motor-mounted or wall-mounted frequency inverters

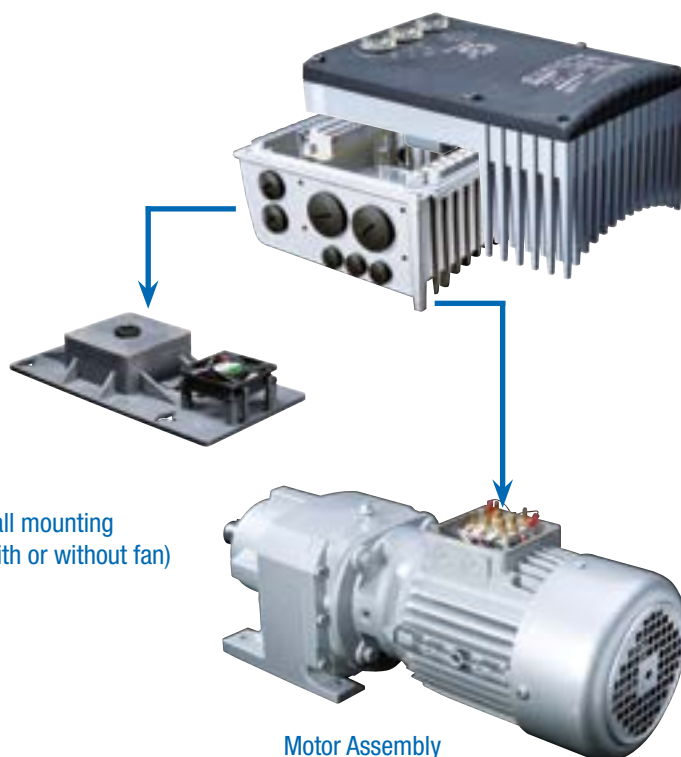

Wall mounting
(with or without fan)

Motor Assembly

Designation	Material	Integrated fan	Achievable protection class	Weight [kg]	(Overall) dimensions L x W x H [mm]	Remarks
SK TIE4-WMK-1-K	Plastic	○	IP66	0,2	205 x 95 x 5	Note: derating as necessary
SK TIE4-WMK-2-K	Plastic	○	IP66	0,3	235 x 105 x 5	Note: derating as necessary
SK TIE4-WMK-L-1	Plastic	●	IP55	0,4	255 x 130 x 24	Fan power: 24 V DC, 1.3 W
SK TIE4-WMK-L-1-C	Plastic	●	IP66	0,4	255 x 130 x 24	Fan power: 24 V DC, 1.3 W
SK TIE4-WMK-L-2	Plastic	●	IP55	0,5	300 x 150 x 30	Note: derating as necessary
SK TIE4-WMK-1-EX	Stainless steel	○	IP66	0,6	205 x 95 x 4	Note: derating as necessary
SK TIE4-WMK-2-EX	Stainless steel	○	IP66	0,8	235 x 105 x 10	ggf. Derating beachten
SK TIE4-WMK-3	Stainless steel	○	IP66	2,4	295 x 255 x 8	
SK TIE4-WMK-TU	Stainless steel	○	IP66	0,4	155 x 85 x 3	

¹ H = increase in the total height of the device if mounted on the wall mounting kit

● Available as standard
○ Not available

Technology unit on NORDAC FLEX or wall mounting



Brake resistors

Internal version

Internal braking resistors SK BRI4

Internal braking resistors are intended for applications in which slight or only sporadic and brief braking (e.g. continuous conveyor equipment, mixing equipment) is to be expected. In addition, they enable the use of the frequency inverter in very confined spaces or in an explosive atmosphere.

Internal brake resistors are intended for installation in the connection unit of the frequency inverter. The devices provide space for the integration of one brake resistor or a set of 2 brake resistors (SK 2x0E, size 4). For thermal reasons, the rated continuous output is limited to 25%. A respective overload protection can be configured via DIP switch.



Frequency inverter SK 2xxE ...	Resistor type	Material No.	Resistance [Ω]	Continuous output [W]	Power consumption ² [kW]	
1 ~ 115 V	0.25 ... 0.75 kW	SK BRI4-1-100-100	275 272 005	100	100 / 25 %	1,0
1 ~ 230 V	0.25 ... 1.1 kW	SK BRI4-1-100-100	275 272 005	100	100 / 25 %	1,0
3 ~ 230 V	0.25 ... 2.2 kW	SK BRI4-1-200-100	275 272 008	200	100 / 25 %	1,0
	3.0 ... 4.0 kW	SK BRI4-2-100-200	275 272 105	100	200 / 25 %	2,0
	5.5 ... 7.5 kW	SK BRI4-3-047-300	275 272 201	47	300 / 25 %	3,0
	11.0 kW	SK BRI4-3-023-600	275 272 800	23	600 / 25 %	6,0
3 ~ 400 V	0.55 ... 4.0 kW	SK BRI4-1-400-100	275 272 012	400	100 / 25 %	1,0
	5.5 ... 7.5 kW	SK BRI4-2-200-200	275 272 108	200	200 / 25 %	2,0
	11.0 ... 15.0 kW	SK BRI4-3-100-300	275 272 205	100	300 / 25 %	3,0
	18.5 ... 22.0 kW	SK BRI4-3-050-600	275 272 801	50	600 / 25 %	6,0

¹ Reduction of the continuous output of the braking resistor to 25% of the rated output

² Permissible max. once within 10 s

Braking resistors External version

External braking resistors SK BRE4

External braking resistors (IP67) are intended for applications in which longer (lifting equipment), frequent (cyclic operation) or intensive (highly dynamic positioning applications) braking is to be expected. They are mounted directly on the frequency inverter. Typically, they can develop high surface temperatures (>70 °C), which exclude their use in an explosive atmosphere.

Note

The braking resistors listed here are designed for typical applications with occasional braking. In case of doubt or for applications with higher braking power (lifting equipment), we recommend specific planning of the necessary brake resistor. Please contact the NORD DRIVE-SYSTEMS Group directly..

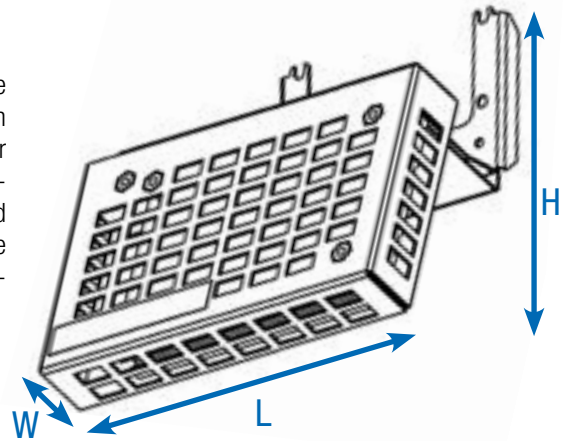

Frequency inverter SK 2xxE ...	Resistor type Material No.	Resistance [Ω]	Continuous output [W]	Power consumption ² [kW]	(Overall) dimensions L x W x H [mm]
1~115V 0.25 ... 0.75 kW	SK BRE4-1-100-100 275 273 005	100	100	2.2	150 x 61 x 178
	Alternatively: SK BRE4-2-100-200 275 273 105	100	200	4.4	255 x 61 x 178
1~230V 0.25 ... 1.1 kW	SK BRE4-1-100-100 275 273 005	100	100	2.2	150 x 61 x 178
	Alternatively: SK BRE4-2-100-200 275 273 105	100	200	4.4	255 x 61 x 178
3~230V 0.25 ... 2.2 kW 3.0 ... 4.0 kW 5.5 ... 11.0 kW	SK BRE4-1-200-100 275 273 008	200	100	2.2	150 x 61 x 178
	Alternatively: SK BRE4-2-200-200 275 273 108	200	200	4.4	255 x 61 x 178
	SK BRE4-2-100-200 275 273 105	100	200	4.4	255 x 61 x 178
	SK BRE4-3-050-450 275 273 201	50	450	3.0	355 x 245 x 318
3~400V 0.55 ... 4.0 kW 5.5 ... 7.5 kW 11.0 ... 22.0 kW	SK BRE4-1-400-100 275 273 012	400	100	2.2	150 x 61 x 178
	Alternatively: SK BRE4-2-200-200 275 273 108	200	200	4.4	255 x 61 x 178
	SK BRE4-2-200-200 275 273 108	200	200	4.4	255 x 61 x 178
	SK BRE4-3-100-450 275 273 205	100	450	3.0	355 x 245 x 318

¹ Permissible max. once within 120 s



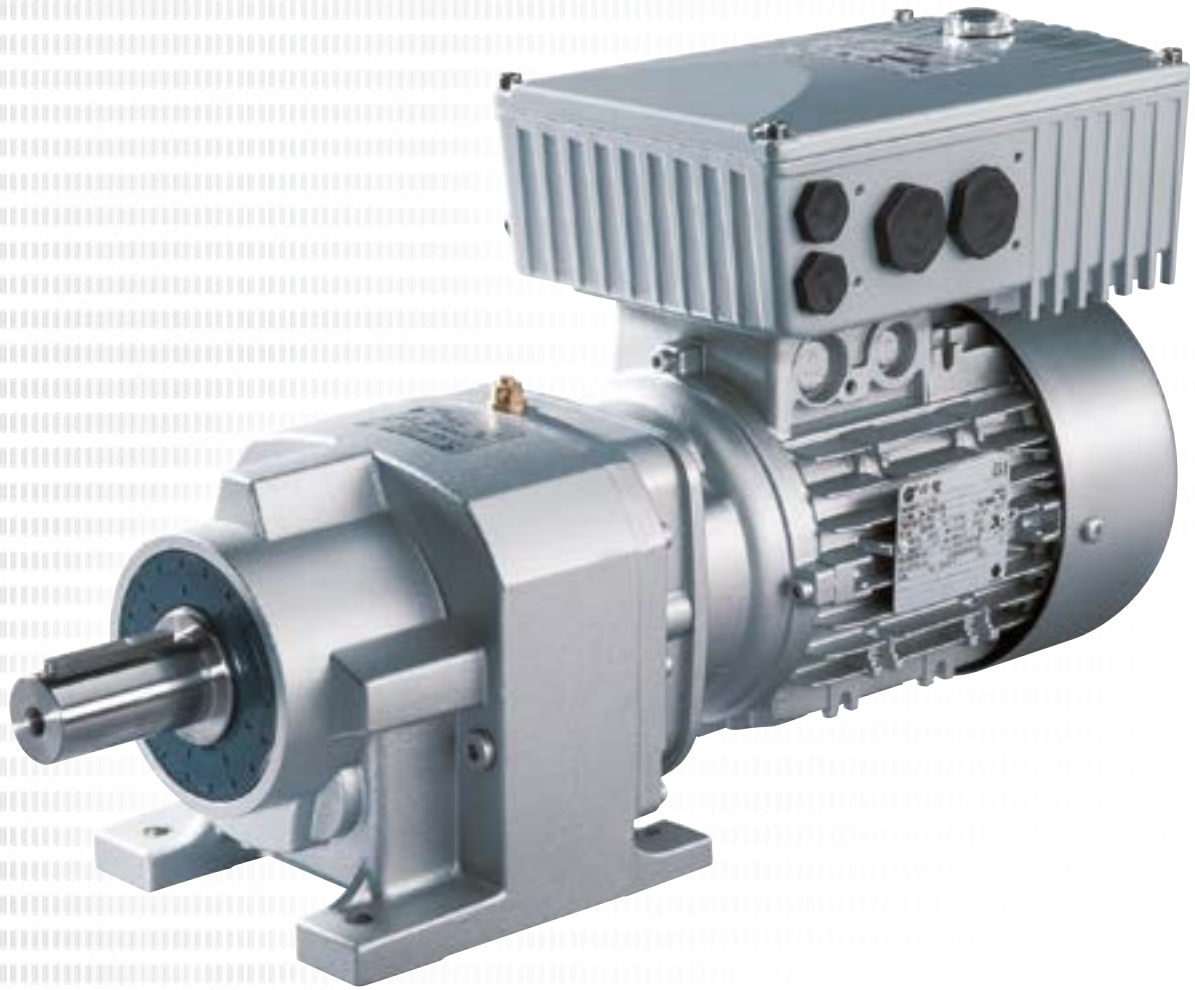

Frequency inverter for decentralised applications

NORDAC *BASE* SK 180E series

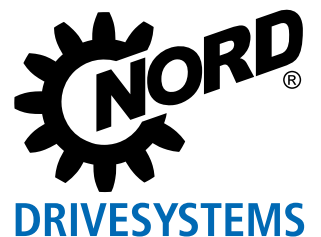

For standard requirements NORDAC *BASE*, SK 180E series



NORDAC *BASE*

The advantages of using a frequency inverter to control an electric motor are obvious. Modern frequency inverters offer the typical basic functions such as speed control and communication with control units as well as versions which, for example, can automatically provide positioning and safety functions.

However, many applications do not fully utilise the immense scope of functions of modern frequency inverters. To fill the gap which has resulted between simple motor starters and full featured frequency inverters, NORD has developed a compact model. It concentrates on the essential functions for pumps and conveyor technology (PI / speed control, energy saving, communication with peripherals) and results in significant savings, in both purchase and performance

- ▶ All common drive functions
- ▶ Leakage current <16 mA
- ▶ Consistent parameter structure
- ▶ Stand-alone operation (integrated 24 V power supply)
- ▶ 3 digital inputs and 2 digital outputs
- ▶ 2 analogue inputs (can optionally be used for current or voltage setpoints, or can also be configured as digital inputs e.g. for sensors)
- ▶ 4 parameter sets which can be switched online
- ▶ Process controller / PI controller
- ▶ Energy saving function: "Automatic flux optimisation"

Optional

- ▶ AS-Interface on board
- ▶ Common bus modules
- ▶ I/O modules
- ▶ System plug connectors (e.g. Harting HAN 10E)
- ▶ Variant for ATEX Zone 22 - 3D
- ▶ Various control options (switches, potentiometer or ParameterBoxes)

Energy-saving functions

- ▶ Automatic flux optimisation for pump/fan applications
- ▶ Large energy savings
- ▶ Simple setting via parameters

EMC line filter

Category C1 (Class B)

- ▶ All 230 V / 400 V devices have an integrated line filter.
- ▶ Also ideal for applications in a domestic environment, due to compliance with Category C1 (for motor-mounting), or Category C2 (for wall mounting with motor cable up to 5 m long)
- ▶ Suitable for personal protection due to low leakage current (< 16 mA) for operation with universal fault current FI circuit breakers

Process controller, PI controller

- ▶ All NORDAC *BASE* devices feature integrated analogue inputs.
- ▶ P and I components can be set separately
- ▶ High precision regulation.

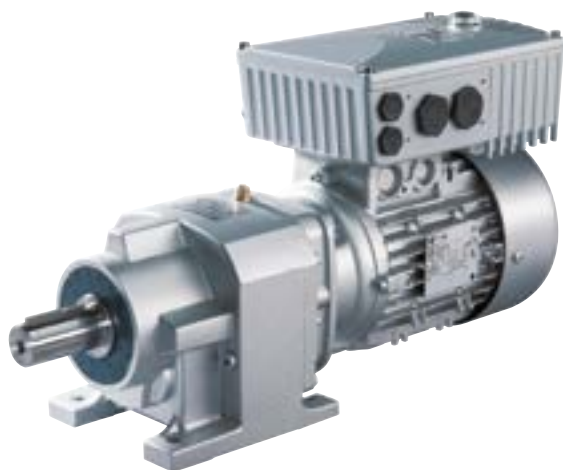

Versatile and sustainable For modern automation systems

Modern automation systems have a wide range of requirements, so that a suitable bus system and drive components must be selected in order to ensure efficient implementation.

For the lower field level, the **AS-Interface** is a cost-effective solution which enables the networking of binary sensors and actuators. With **NORDAC BASE**, a version which provides an appropriate solution by means of an on-board AS-Interface, is available for this price-sensitive area.

The supply voltage (power) is connected separately via the corresponding terminals. An integrated mains unit generates the control voltage for the frequency inverter. This eliminates the need for an additional AUX cable (black).





Available in SK 190E



Device SK ...	190E
Slave profile	S-7.A.
Slave type	A/B-Slave
Control voltage	Internal power supply
Inputs/Outputs	4/4
Configuration via parameters	●

Standards and approvals

All devices of the entire series comply with the standards and directives listed below..

Approval	Directive	Applied standards	Certificates	Code
CE (European Union)	Low Voltage Directive 2014/35/EU	EN 61800-5-1	C310400	
	EMC 2014/30/EU	EN 60529	C310401	
	RoHS 2011/65/EU	EN 61800-3 EN 63000		
	Delegated directive (EU) 2015/863	EN 61800-9-1 EN 61800-9-2		
	Ecodesign 2009/125/EG			
	Regulation (EU) 2019/1781 Ecodesign			
UL (USA)		UL 61800-5-1	E171342	
CSA (Canada)		C22.2 No. 274-13	E171342	
RCM (Australia)	F2018L00028	EN 61800-3	133520966	
EAC (Eurasia)	TR CU 004/2011, TR CU 020/2011	IEC 61800-5-1 IEC 61800-3	EAЭC N RU Д-DE. HB27.B.02730/20	
UkrSEPRO (Ukraine)		EN 61800-5-1 EN 60529 EN 61800-3 EN 63000 EN 60947-1 EN 60947-4 EN 61558-1 EN 50581	C311900	
UKCA (United Kingdom)		EN 61800-5-1 EN 60529 EN 61800-3 EN 63000 EN 61800-9-1 EN 61800-9-2	C350400, C350401	

Devices which are configured and approved for use in explosion hazard environments comply with the following directives and standards.

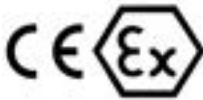
Approval	Directive	Applied standards	Certificates	Code
CE (European Union)	ATEX	2014/34/EU	EN 60079-0	
	Low Voltage Directive	2014/35/EU	EN 60079-31	
	EMV	2014/30/EU	EN 61800-5-1 EN 60529	
	RoHS	2011/65/EU	EN 61800-3	
	Delegated directive (EU)	2015/863	EN 63000 EN 61800-9-1 EN 61800-9-2	
	Ecodesign	2009/125/EG		
	Regulation (EU)	2019/1781		
	Ecodesign			

Type code

Frequency inverter

SK 180E-370-323-B (-C) (xxx)

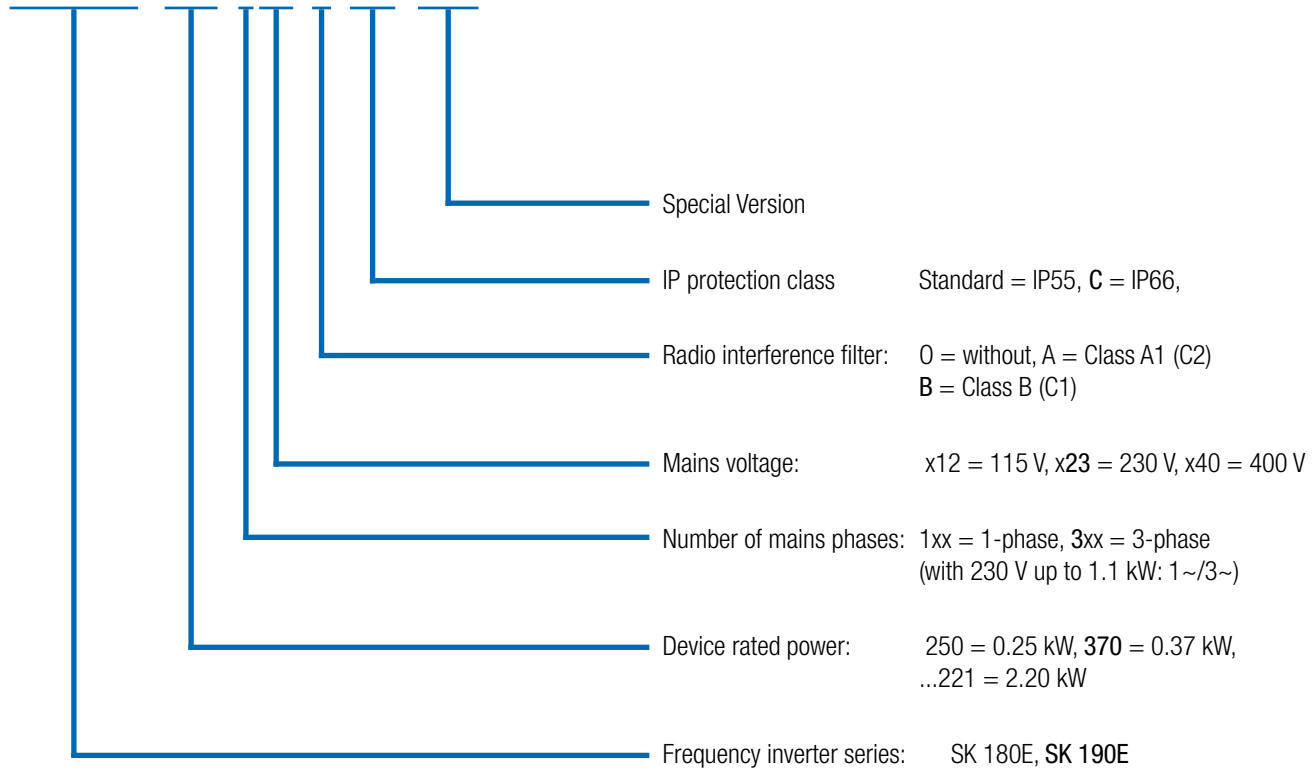

(...) Options, only implemented if required.

ATEX-compliant drive systems, zone 22 3D

The NORDAC *BASE* can be modified for operation in explosive environments.

This allows the operation of the frequency inverter directly in a hazardous area (ATEX 22-3D). The advantages are obvious:

- ▶ Compact drive unit
- ▶ No complex protective devices
- ▶ No motor cables
- ▶ Optimum EMC
- ▶ Permissible characteristic curves 50 Hz / 87 Hz
- ▶ Control range up to 100 Hz or 3000 rpm

Depending on the area of application (conductive or non-conductive dust) the modification also includes the replacement of the transparent diagnostic caps with a version made of aluminium and glass.

It must be noted that operation of the device within the hazardous area is only permitted with integrable modules (SK CU4 modules, internal braking resistors) or specially approved accessories (ATEX potentiometer „SK ATX-POT“).

There are exceptions for SK TU4 modules, which are described in detail in the manual for the device. Other accessories (e.g. external brake resistors, plug connectors) are not approved for use within a hazardous area.



Approval

- ▶ According to 2014/34/EU
- ▶ ATEX Zone 22 - 3D
 - ▶ Version for non-conducting dust: IP55
 - ▶ Version for conducting dust: IP66

Available in all devices



The entire team

All device versions at a glance

	SK 180E Size 1+2 0.25 - 2.2 kW	SK 190E Size 1+2 0.25 - 2.2 kW
Motor and wall mounting possible ¹	●	●
Energy bus - loop-through of mains supply cables ²	●	●
Communication bus for various devices ²	●	●
Sensorless current vector control (ISD control)	●	●
Brake chopper (braking resistor optional) (Size 2 and above)	●	●
RS-232, RS-485 diagnostic interface	●	●
4 switchable parameter sets	●	●
Parameters pre-set with standard values	●	●
Automatic determination of motor data	●	●
Energy-saving function, optimised efficiency in partial load operation	●	●
Integrated EMC line filter according to EN 61800-3, Category C2 up to 5 m motor cable Category C1 for motor assembly	●	●
Extensive monitoring functions	●	●
Load monitor	●	●
PI controller	●	●
Process controller / compensator control	●	●
PLC functionality	●	●
IE4 Synchronous motor operation (PMSM)	●	●
Modification for operation in an IT network by means of jumpers	●	●
All common field bus systems	●	●
Brake management for mechanical holding brake	●	●
Lifting gear functionality	●	●
AS-Interface on board	○	●
Internal 24 V power supply unit to supply the control board	●	●
Internal / external brake resistors (Size 2)	●	●
Switch and potentiometer versions	●	●
Plug connectors for connection of control, motor and mains cables	●	●

¹ Wall mounting: wall mounting kit required

Motor mounting: an adapter for connection to the motor terminal box may be necessary

² Direct connection to the terminal bar or via system plug connectors

● Available as standard

● Optional

○ Not available

Introduction
NORDAC PRO SK 500P
NORDAC PRO SK 500E
NORDAC LINK
NORDAC ON
NORDAC FLEX
NORDAC BASE
NORDAC START
Accessories

The senses

Control connections on the frequency inverter

	SK 180E	SK 190E	
	Size 1 + 2 0.25 - 2.2 kW		
Control terminals	Number of digital inputs (DIN)	3	3
	Number of digital outputs (DOUT)	2	2
	Number of analogue inputs (AIN) ¹	2	2
	Temperature sensor (PTC)	●	●
Communication	RS485 / RS232 RJ12	●	●
	AS-I terminal connection	○	●

¹ 0(2) - 10 V, 0(4) - 20 mA

Connection and control terminals



Communication

Note

Control terminals can be supplemented by optional modules (IOs, brake management).

Status and diagnostic cockpit

The RJ12 interface for connection of a diagnostic and parameterisation tool (e.g. PC with NORD CON software, ParameterBox) is located behind the transparent cover cap. Analysis, diagnostics, parameterisation and monitoring of the drive unit via software is possible during commissioning or service. In addition to status and readiness indicators, the current overload level, warnings and error messages are indicated in coded form by the LEDs.



NORDAC *BASE* frequency inverter

1 ~ 110 ... 120 V , 1 / 3 ~ 200 ... 240 V UND 3 ~ 380 ... 400 V

Output frequency	0.0 ... 400.0 Hz	Protection class	IP55, optional IP66, NEMA type1
Pulse frequency	3.0 ... 16.0 kHz	Regulation and control	Sensorless current vector control (ISD), linear V/f characteristic curve
Typical overload capacity	150 % for 60 s, 200 % for 3.5 s	Motor temperature monitoring	I ² t Motor PTC / bi-metal switch
Energy efficiency class	IE2	Leakage current	< 16 mA
Efficiency	> 95 %		
Ambient temperature	-25 °C ... +40 °C (S1) -25 °C ... +50 °C (S3, - 70 % ED)		

Frequency inverters SK 180E...	Nominal motor power		Nominal output current rms [A]	Mains voltage	Output voltage
	230 V [kW]	240 V [hp]			
-250-112-0 (-C)	0.25	1/3	1.7	1 ~ 110...120 V -/+10 % 47 ... 63 Hz	3 ~ AC 0 V up to double the mains voltage
-370-112-0 (-C)	0.37	1/2	2.1		
-550-112-0 (-C)	0.55	3/4	3.0		
-750-112-0 (-C)	0.75	1	3.7		

Frequency inverters SK 180E...	Nominal motor power		Nominal output current rms [A]	Mains voltage	Output voltage
	230 V [kW]	240 V [hp]			
-250-323-B (-C)	0.25	1/3	1.7	1/3 ~ 200 ... 240 V, -/+ 10 % 47 ... 63 Hz	3 ~ AC 0 V up to mains voltage
-370-323-B (-C)	0.37	1/2	2.2		
-550-323-B (-C)	0.55	3/4	3.0		
-750-323-B (-C)	0.75	1	4.0		
-111-323-B (-C)	1.1	1 1/2	5.5		
-151-323-B (-C)	1.5	2	7.0	3 ~ 200 ... 240 V, -/+ 10 % 47 ... 63 Hz	3 ~ AC 0 V up to mains voltage

Frequency inverters SK 180E...	Nominal motor power		Nominal output current rms [A]	Mains voltage	Output voltage
	400 V [kW]	480 V [hp]			
-250-340-B (-C)	0.25	1/3	1.2	3 ~ 380...480 V, -20 % / +10 %, 47 ... 63 Hz	3 ~ AC 0 V up to mains voltage
-370-340-B (-C)	0.37	1/2	1.5		
-550-340-B (-C)	0.55	3/4	1.7		
-750-340-B (-C)	0.75	1	2.3		
-111-340-B (-C)	1.1	1 1/2	3.1		
-151-340-B (-C)	1.5	2	4.0		
-221-340-B (-C)	2.2	3	5.5		

IP66 measures

- ▶ Coated aluminium components
- ▶ Coated circuit boards
- ▶ Low-pressure test
- ▶ Diaphragm valve

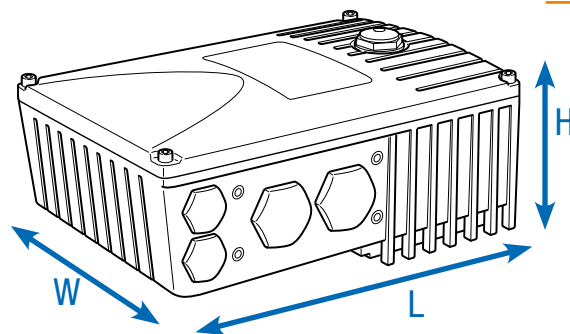

Frequency inverters SK180E ...	Weight [kg]	(Overall) dimensions L x W x H [mm]	Size
-250-112-0 (-C)	2.9	221 x 154 x ca.101	1
-370-112-0 (-C)	2.9	221 x 154 x ca.101	1
-550-112-0 (-C)	2.9	221 x 154 x ca.101	1
-750-112-0 (-C)	2.9	221 x 154 x ca.101	1

Frequency inverters SK180E ...	Weight [kg]	(Overall) dimensions L x W x H [mm]	Size
-250-323-B (-C)	2.9	221 x 154 x ca.101	1
-370-323-B (-C)	2.9	221 x 154 x ca.101	1
-550-323-B (-C)	2.9	221 x 154 x ca.101	1
-750-323-B (-C)	4.1	254 x 165 x ca.123	2
-111-323-B (-C)	4.1	254 x 165 x ca.123	2
-151-323-B (-C)	4.1	254 x 165 x ca.123	2

Frequency inverters SK180E ...	Weight [kg]	(Overall) dimensions L x W x H [mm]	Size
-250-340-B (-C)	2.9	221 x 154 x ca.101	1
-370-340-B (-C)	2.9	221 x 154 x ca.101	1
-550-340-B (-C)	2.9	221 x 154 x ca.101	1
-750-340-B (-C)	2.9	221 x 154 x ca.101	1
-111-340-B (-C)	2.9	221 x 154 x ca.101	1
-151-340-B (-C)	4.1	254 x 165 x ca.123	2
-221-340-B (-C)	4.1	254 x 165 x ca.123	2

Varied installation possibilities

Motor Assembly

The frequency inverter can be mounted directly on the terminal box of the (geared) motor, thus forming a perfect unit consisting of the drive and the control technology. This motor-mounted format makes full use of its unbeatable advantages: compact overall dimensions of the drive unit, practically immediate readiness for use after connection to the mains supply thanks to the pre-configuration of the drive unit at the factory, optimum EMC due to short cable lengths - or elimination of a motor cable.

Wall mounting

As an alternative to motor mounting, the device can be mounted close to the motor with the aid of an optional wall mounting kit.

You can select from different versions depending on the prevalent ambient conditions.

1. Standard version SK TIE4-WMK-1-K

Note: If the frequency inverter is wall mounted, the cooling air flow from the motor is not present. This can ultimately result in power restrictions (derating) for the frequency inverter.

2. ATEX version SK TIE4-WMK-1-EX

This version is functionally comparable to the standard version, however it is suitable for use in explosion hazard environments (ATEX Zone 22 3D).

Designation	Material No.	Frequency inverters ¹ for size FI
SK TIE4-WMK-1-K	275 274 004	BG 1, 2
SK TIE4-WMK-1-EX	275 175 053	BG 1, 2
SK TIE4-WMK-TU ²	275 274 002	Typ: SK TU4-

¹ Mounting of the WMK underneath the motor starter

² Mounting of the WMK on the connection unit of the technology unit

Motor-mounted or wall-mounted frequency inverters

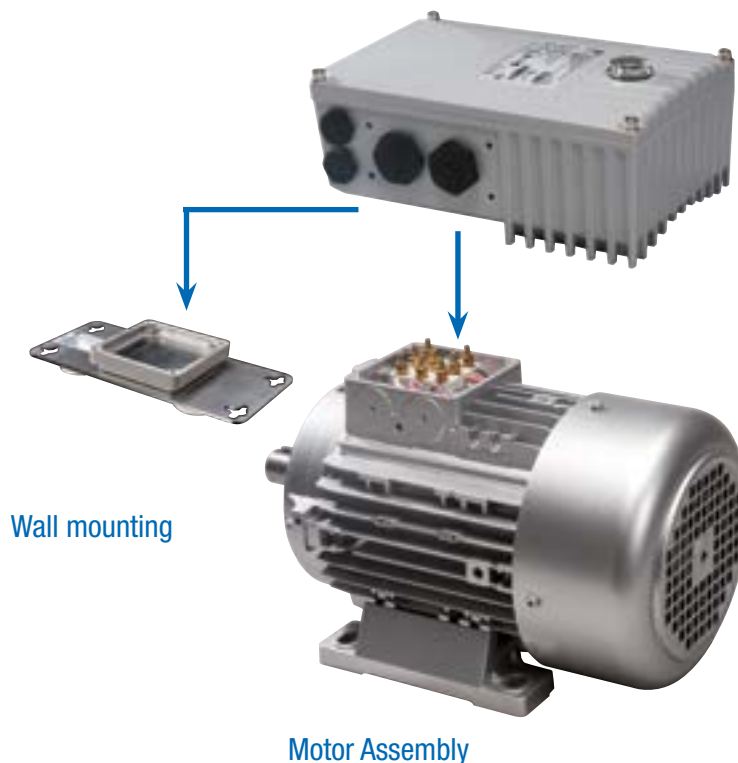

Designation	Material	Integrated fan	Achievable protection class	Weight [kg]	(Overall) dimensions L x W x H [mm]	Remarks
SK TIE4-WMK-1-K	Plastic	○	IP66	0.2	205 x 95 x 5	Note: derating as necessary
SK TIE4-WMK-1-EX	Stainless steel	○	IP66	0.6	205 x 95 x 4	Note: derating as necessary
SK TIE4-WMK-TU	Stainless steel	○	IP66	0.4	155 x 85 x 3	

¹ H = Increase in the total height of the device if mounted on the wall mounting kit

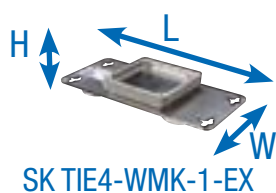

Technology unit on NORDAC BASE or wall mounting

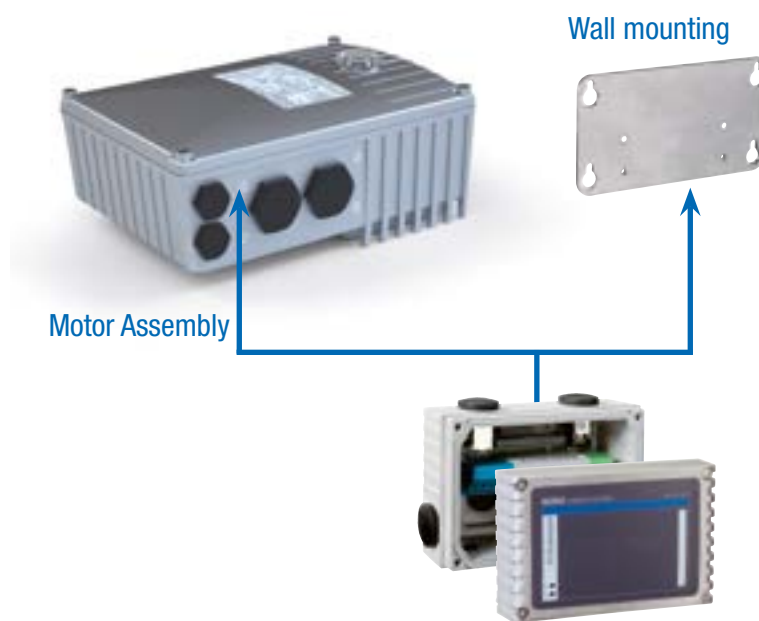

Brake resistors (only for Size 2 devices) internal versions

Internal braking resistors SK BRI4

Internal brake resistors are intended for applications in which slight or only sporadic and brief braking (e.g. continuous conveyor equipment, mixing equipment) is to be expected. In addition, they enable the use of the frequency inverter in very confined spaces or in an explosive atmosphere.

Internal brake resistors are intended for installation in the connection unit of the frequency inverter. The units offer space for implementing one brake resistor each. For thermal reasons, the rated continuous output is limited to 25%.

Equipment with a brake resistor has to be specified additionally during ordering. Retrofitting is not possible.



Frequency inverters SK 180E / SK190E	Resistor type	Material No.	Resistance [Ω]	Continuous output ¹ [W]	Power consumption ² [kW]
1/3~ 230 V 0.75 ... 1.5 kW	SK BRI4-1-200-100	275 272 008	200	100 / 25 %	1.0
3~ 400 V 1.5 ... 2.2 kW	SK BRI4-1-400-100	275 272 012	400	100 / 25 %	1.0

¹ Reduction of the continuous output of the braking resistor to 25% of the rated output

² Permissible max. once within 10 s

Brake resistors (ONLY FOR SIZE 2 DEVICES) external versions

External braking resistors SK BRE4

External braking resistors (IP67) are intended for applications in which longer (lifting equipment), frequent (cyclic operation) or intensive (highly dynamic positioning applications) braking is to be expected. They are mounted directly on the frequency inverter. Typically, they can develop high surface temperatures (>70 °C), which exclude their use in an explosive atmosphere.

Note

The brake resistors listed here are designed for typical applications with occasional braking. In case of doubt or for applications with higher braking power (lifting equipment), we recommend targeted planning of the necessary brake resistor. Please contact the NORD DRIVESYSTEMS Group directly.

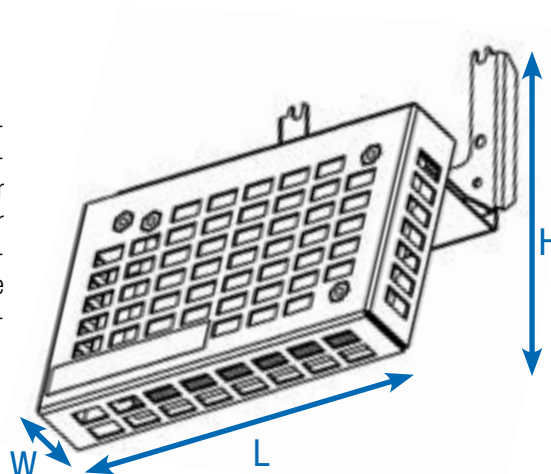

Frequency inverters SK 180E / SK190E	Resistor type Material No.	Resistance [Ω]	Continuous output [W]	Power consumption ¹ [kW]	(Overall) dimensions L x W x H [mm]
1/3~ 230V 0.75 ... 1.5 kW	SK BRE4-1-100-100 275 273 005	100	100	2.2	150 x 61 x 178
	Alternatively: SK BRE4-2-100-200 275 273 105	100	200	4.4	255 x 61 x 178
3~ 400V 1.5 ... 2.2 kW	SK BRE4-1-200-100 275 273 008	200	100	2.2	150 x 61 x 178
	Alternatively: SK BRE4-2-200-200 275 273 108	200	200	4.4	255 x 61 x 178

¹ Permissible max. once within 120 s

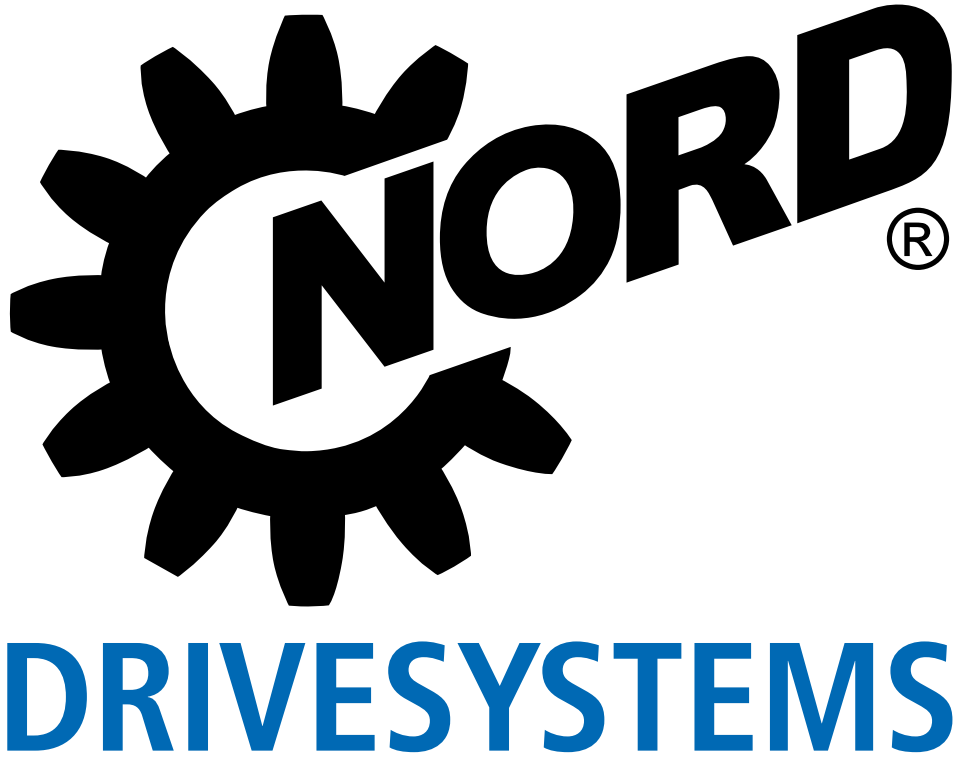



Motor starter decentralised applications

NORDAC *START* SK 135E series

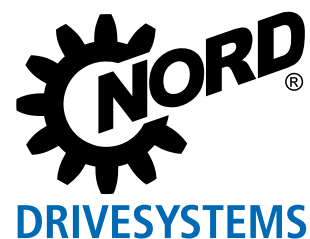

Switch on and start working!

NORDAC *START*, SK 135E series



[NORDAC *START*](#)

NORDAC *START*

Mains-powered electric motors

are very widespread. They require low installation and commissioning effort.

On the other hand, disadvantages include the high power consumption for the starting torque (up to 7 times the rated current for the motor), excessive mechanical loads on the gear unit and the system, as well as the frequently uncontrolled starting and stopping behaviour. Electronic starters are a simple and very economical solution to this problem. However, NORD devices are far more than simple current limiting “starters” for electric motors.

NORDAC *START*

combines the 3 functions of a typical “electronic motor starter”, which are known under the terms starter, reversing starter and soft starter.

The NORDAC *START* provides comprehensive monitoring and protective functions (mains/motor/self-monitoring) and also eliminates the need for a motor protection switch. It enables individual adaptations to the operating characteristics (starting / shut-down behaviour) and provides optional communication interfaces. A special feature is the variable mounting of the device. In confined spaces it has the advantage that the compact device can be easily used for operation close to the motor.

Many applications,

including those in material handling, require electronic starting and stopping of the drive units. The NORDAC *START* is ideally suited for this. Its versatility makes both motor starting functions and soft starting or reversing mode possible. Extensive monitoring functions provide protection from overheating, for example. Due to the I²t triggering characteristic, a motor protection switch is not required. Through the integrated line filter, the NORDAC *START*, complies with even the most stringent EMC requirements when mounted on the motor.

- ▶ Configuration via DIP switches and potentiometers
- ▶ Integrated electronic brake rectifier
- ▶ Choice of different shut-down modes
- ▶ Leakage current <20 mA
- ▶ Consistent parameter structure
- ▶ 2 digital inputs and outputs

Optional

- ▶ Bus interface on board
 - ▶ AS-Interface (implemented as SK 175E-ASI)
 - ▶ PROFIBUS® DP (implemented as SK 175E-PBR)
- ▶ System plug connectors (e.g. Harting HAN 10E)
- ▶ Variant for ATEX Zone 22 - 3D
- ▶ Various control options (switches, ParameterBox)
- ▶ 24V mains unit

Variable operating characteristics

- ▶ Pre-defined shut-down modes
- ▶ Variable starting and shut-down ramps
- ▶ Boost function

EMC Line Filter Class B

- ▶ Integrated line filter
- ▶ Also ideal for applications in a domestic environment, due to compliance with Class B (for motor-mounting or motor cables up to 10 m), or Class A, for wall mounting with motor cables up to 100 m long
- ▶ Suitable for personal protection due to low leakage current (< 20 mA) for operation with universal fault current FI circuit breakers

Commissioning

- ▶ Commissioning via integrated DIP switches and potentiometer
- ▶ No programming skills required



Standards and approvals

All devices of the entire series comply with the standards and directives listed below..

Approval	Directive	Applied standards	Certificates	Code
CE (European Union)	Low Voltage Directive 2014/35/EU	EN 60947-1 EN 60529	C310800	
	EMV 2014/30/EU	EN 60947-4-2 EN 63000		
	RoHS Delegated directive (EU) 2011/65/EU 2015/863			
UL (USA)		UL 60947-1 UL 60947-4-2	E365221	
CSA (Canada)		C22.2 No. 60947-1-13 C22.2 No. 60947-4-2-14	E365221	
RCM (Australia)	F2018L00028	EN 60947-1 EN 60947-4-2	133520966	
EAC (Eurasia)	TR CU 004/2011, TR CU 020/2011	IEC 60947-1 IEC 60947-4-2	EAЭC N RU Д-DE. HB27.B.02732/20	
UkrSEPRO (Ukraine)		EN 60947-1 EN 60529 EN 60947-4-2 EN 63000 EN 60947-1 EN 60947-4 EN 61558-1 EN 50581	C311900	
UKCA (United Kingdom)		EN 60947-1 EN 60529 EN 60947-4-2 EN 63000 EN 61800-9-1 EN 61800-9-2	C350800	

Introduction
NORDAC PRO SK 500P
NORDAC PRO SK 500E
NORDAC LINK
NORDAC ON
NORDAC FLEX
NORDAC BASE
NORDAC START
Accessories

Devices which are configured and approved for use in explosion hazard environments comply with the following directives and standards.

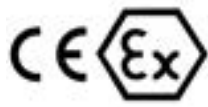
Approval	Directive	Applied standards	Certificates	Code
CE (European Union)	ATEX	2014/34/EU	EN 60079-0 EN 60079-31	C432810 
	EMV	2014/30/EU	EN 63000 EN 60529	
	RoHS	2011/65/EU	EN 60947-1	
	Delegated directive (EU)	2015/863	EN 60947-4-2	

Type code

Motor starters

SK 175E-751-340-B (-ASI) (-C) (xxx)

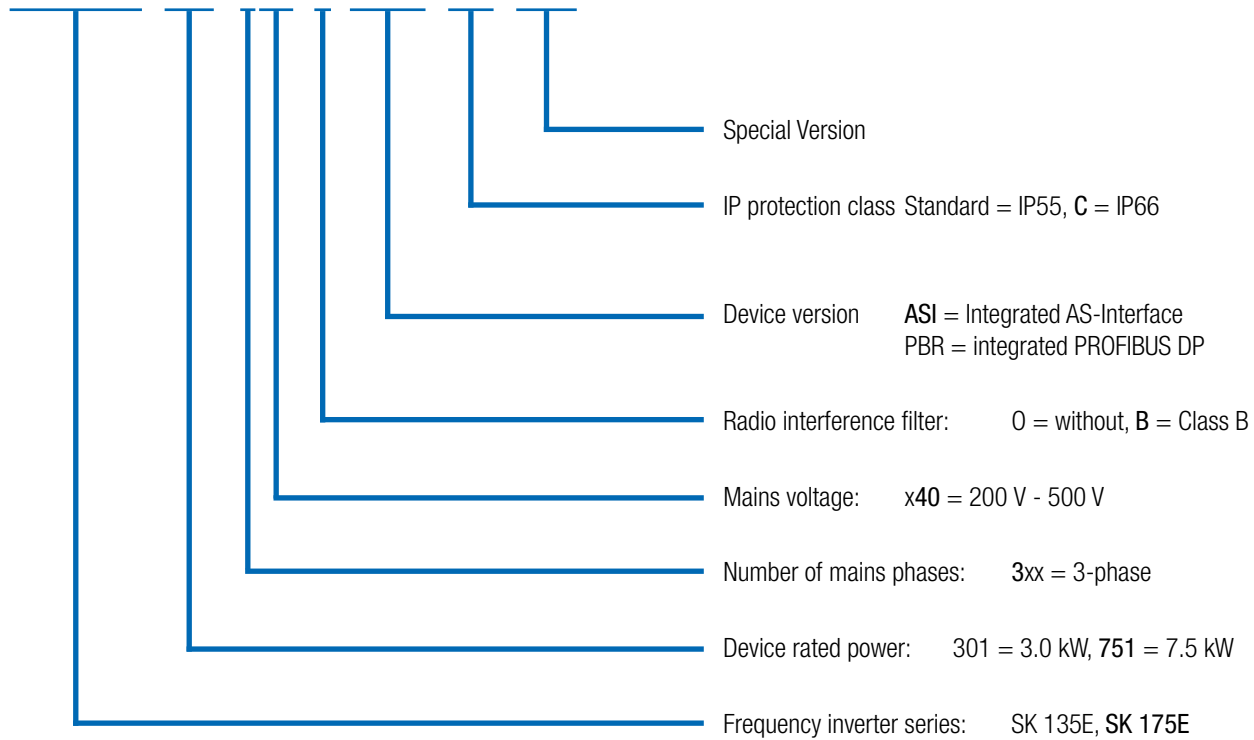

(...) Options, only implemented if required.

Versatile and sustainable Communication and more

Modern automation systems have a wide range of requirements, so that a suitable bus system and drive components must be selected in order to ensure efficient implementation.

AS-Interface

For the lower field level, the AS-Interface is a cost-effective solution which enables the networking of binary sensors and actuators. With *NORDAC START*, special versions which provide an appropriate solution by means of an AS-Interface, are available for this price-sensitive area.

The supply voltage (power) is connected separately via the corresponding terminals. Depending on the device configuration (with jumpers), the control voltage of the motor starter is supplied via the yellow AS-Interface cable, or separately via the black (AUX) cable.

Available in all SK 175E ... ASI devices



Power
(230 V / 400 V)

AS-Interface
including 24 V supply
(configurable)

PROFIBUS DP®

This bus system allows for cyclic exchange of 4 control or 4 status bits via a process data object (with up to 12 Mbps). Addressing is performed via a rotary encoding switch. The PROFIBUS® terminator can be enabled with a jumper. Connection is possible with terminal strips or M12 plug connectors.

Available in all SK 175E ... ASI devices



Jumper Position	AUX	ASI
Slave profile	S-7.A.	S-7.A.
Slave type	A/B-slave	A/B-slave
Control voltage	Black AS-I cable	Yellow AS-I cable
Inputs/Outputs	4/4	4/4
Configuration via DIP-switch	●	●
Configuration via parameters	●	●



ATEX-compliant drive systems, zone 22 3D

The NORDAC *START* can be modified for operation in explosive environments.

This allows the operation of the motor starter directly in a hazardous area (ATEX 22-3D). The advantages are obvious:

- ▶ Compact drive unit
- ▶ No complex protective devices
- ▶ No motor cables
- ▶ Optimum EMC

Depending on the area of application (conductive or non-conductive dust) the modification also includes the replacement of the transparent diagnostic caps with a version made of aluminium and glass.

It must be noted that operation of the device within the hazardous area is only permitted with integrable modules (SK CU4 modules, internal braking resistors) or specially approved accessories.

There are exceptions for SK TU4 modules, which are described in detail in the manual for the device. Other accessories (e.g. external brake resistors, plug connectors) are not approved for use within a hazardous area.

Approval

- ▶ According to 2014/34/EU
- ▶ ATEX Zone 22 - 3D
 - ▶ Version for non-conducting dust: IP55
 - ▶ Version for conducting dust: IP66

Available in all devices



Motor starter NORDAC *START*

3~ 200 ... 500 V

Typical overload capacity 150 % for 120 s
up to 360 s (adjustable)

Motor starter efficiency > 98 %

Ambient temperature -25 °C...+50 °C (S1),
-25 °C +60 °C (S3 - 70 % ED)

Protection class IP55 optional IP66
NEMA type1

IP66 measures

- ▶ Coated aluminium components
- ▶ Coated circuit boards
- ▶ Low-pressure test

Protective measures against

- ▶ Mains phase failure
- ▶ Motor phase failure
- ▶ Flux monitoring
- ▶ Motor over temperature (PTC)
- ▶ Motor overload
- ▶ Mains over/under voltage

Motor temperature monitoring

I²t Motor
PTC / bi-metal switch

Leakage current

< 20 mA

Motor starters SK 135 E... / SK 175 E...	Nominal motor power		Nominal output current rms [A]	Mains voltage / output voltage	Weight [kg]	(Overall) dimensions L x W x H [mm]
	[kW]	[hp]				
-301-340-B	up to 3.0	up to 4	7.5	3~ 200 V ... 500 V, -10 % / +10 %, 47 ... 63 Hz	2.1	221 x 154 x ca.101
-751-340-B	up to 7.5	up to 10	16.0			

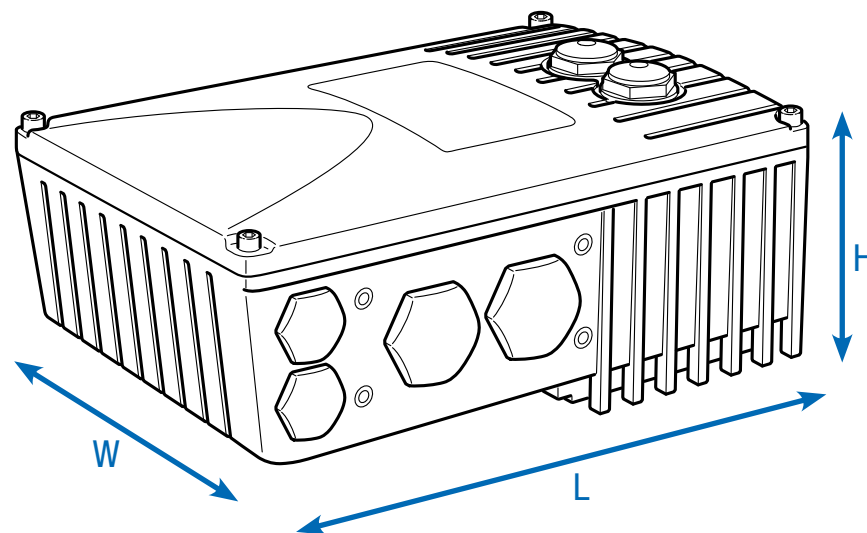

The entire team

All device versions at a glance

	SK 135E 0.25 - 7.5 kW	SK 175E - ASI 0.25 - 7.5 kW	SK 175E - PBR 0.25 - 7.5 kW
Soft start function	●	●	●
Reversing function	●	●	●
Motor and wall mounting possible ¹	●	●	●
Energy bus - loop-through of mains supply cables ²	●	●	●
RS-232 diagnostic interface	●	●	●
Parameters pre-set with standard values	●	●	●
Integrated EMC line filter according to EN 60947-4-2, Class B up to 10 m motor cable and for motor assembly	●	●	●
Integrated EMC line filter according to EN 60947-4-2, Class A up to 100 m motor cable and for motor assembly	●	●	●
Extensive monitoring functions	●	●	●
Brake management for mechanical holding brake	●	●	●
AS-Interface on board	○	●	○
PROFIBUS DP® on board	○	○	●
External 24 V power supply for the control board	●	●	●
Switch variants	●	●	●
Plug connectors for connection of control, motor and mains cables	●	●	●

¹ Wall mounting: wall mounting kit required
 Motor mounting: an adapter for connection to the motor terminal box may be necessary.
² Direct connection to the terminal bar or via system plug connectors

● Available as standard
 ● Optional
 ○ Not available

Introduction
 NORDAC PRO SK 500P
 NORDAC PRO SK 500E
 NORDAC LINK
 NORDAC ON
 NORDAC FLEX
 NORDAC BASE
 NORDAC START
 Accessories

The senses

Control connections on the motor starter

	SK 135E 0.25 - 7.5 kW	SK 175E - ASI 0.25 - 7.5 kW	SK 175E - PBR 0.25 - 7.5 kW
Control terminals	Number of digital inputs (DIN)	2	2 (+2 sensor inputs for Bus)
	Number of digital outputs (DOUT)	2	2
	Brake control	●	●
	Temperature sensor (PTC)	●	●
Communication	RS-232 RJ12	●	●
	AS-I terminal connection	○	●
	PROFIBUS DP® terminal connection	○	●

Note

Control terminals can be added with optional modules (IOs, device protection).

- Available as standard
- Not available



Configuration and monitoring

Integrated aids for safe operation



Commissioning with a screwdriver

Commissioning of the device is basically possible without parameter adaptation, i.e. without programming aids. For this purpose, DIP switches and several 10 step potentiometers are available. These are accessible via the diagnostic opening in the centre or by removing the cover. The status LEDs of the device are also located behind this diagnostic opening.

The following parameters can be adjusted in this way:

- ▶ Rated motor current
- ▶ Locking time
- ▶ Start-up torque
- ▶ Start-up and run-down time
- ▶ Switch-off mode
- ▶ Phase sequence detection
- ▶ Automatic start
- ▶ PROFIBUS DP® addressing (only SK 175E-...-PBR)

Jumpers for configuration

The communication interface can be configured by changing the jumper position.

- ▶ SK 175E-...-ASI: Communication mode
 - ▶ ASI (supply for interface and device via yellow cable) or
 - ▶ AUX (supply for interface via yellow cable and for device via black cable)
- ▶ SK 175E-...-PBR: Interface terminator

Available in all SK 175E devices

Status and diagnostic cockpit

Depending on the type of device, various aids for monitoring the device or for diagnosis in case of faults are located behind two transparent cover caps. In addition, there are further elements (e.g. potentiometers or similar) which are useful for “screwdriver-assisted commissioning”



1 Status LEDs and potentiometers

In addition to status and readiness indicators, the actual overload level, warnings and error messages of the integrated bus system (SK 175E) are indicated in coded form by the LEDs.

Operational settings of the motor starter can be set with the potentiometers.

2 Diagnostic interface, RS-232

RJ12 interface for connection of a diagnostic and parameterisation tool (e.g. PC with NORDCON software, ParameterBox1). Analysis, diagnostics, parameterisation and monitoring of the drive unit via software is possible during commissioning or service.

¹ Use of a parameterisation unit also requires the use of a signal converter. (SK TIE4-RS-485-RS-232, material no. 275 274 603)

Varied installation possibilities

Motor Assembly

The motor starter can be mounted directly on the terminal box base of the (geared) motor, thus forming a perfect unit consisting of the drive and the control technology. This motor-mounted format makes full use of its unbeatable advantages: compact overall dimensions of the drive unit, practically immediate readiness for use after connection to the mains supply thanks to the pre-configuration of the drive unit at the factory, optimum EMC due to short cable lengths - or elimination of a motor cable.

Wall mounting

As an alternative to motor mounting, the device can be mounted close to the motor with the aid of an optional wall mounting kit.

You can select from different versions depending on the prevalent ambient conditions.

1. Standard version SK TIE4-WMK-1-K

2. ATEX version SK TIE4-WMK-1-EX

This version is functionally comparable to the standard version, however it is suitable for use in explosion hazard environments (ATEX Zone 22 3D).

Designation	Material No.	Frequency inverters ¹ for size FI
SK TIE4-WMK-1-K	275 274 004	BG 1
SK TIE4-WMK-2-K	275 274 015	BG 2
SK TIE4-WMK-1-EX	275 175 053	BG 1
SK TIE4-WMK-2-EX	275 175 054	BG 2
SK TIE4-WMK-TU ²	275 274 002	Typ: SK TU4-

¹ Mounting of the WMK underneath the motor starter

² Mounting of the WMK on the connection unit of the technology unit

Motor-mounted or wall-mounted motor starters

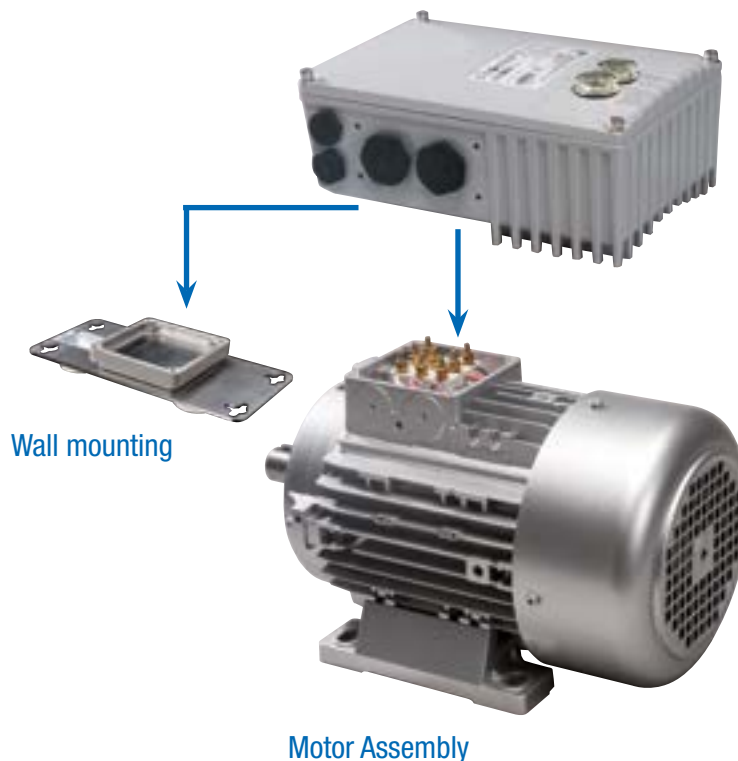

Designation	Material	Integrated fan	Achievable protection class	Weight [kg]	(Overall) dimensions L x W x H [mm]	Remarks
SK TIE4-WMK-1-K	Plastic	-	IP66	0,2	205 x 95 x 5	
SK TIE4-WMK-2-K	Plastic	-	IP66	0,3	235 x 105 x 5	
SK TIE4-WMK-1-EX	Stainless steel	-	IP66	0,6	205 x 95 x 4	
SK TIE4-WMK-2-EX	Stainless steel	-	IP66	0,8	235 x 105 x 10	
SK TIE4-WMK-TU	Stainless steel	-	IP66	0,4	155 x 85 x 3	

¹ H = Increase in the total height of the device if mounted on the wall mounting kit

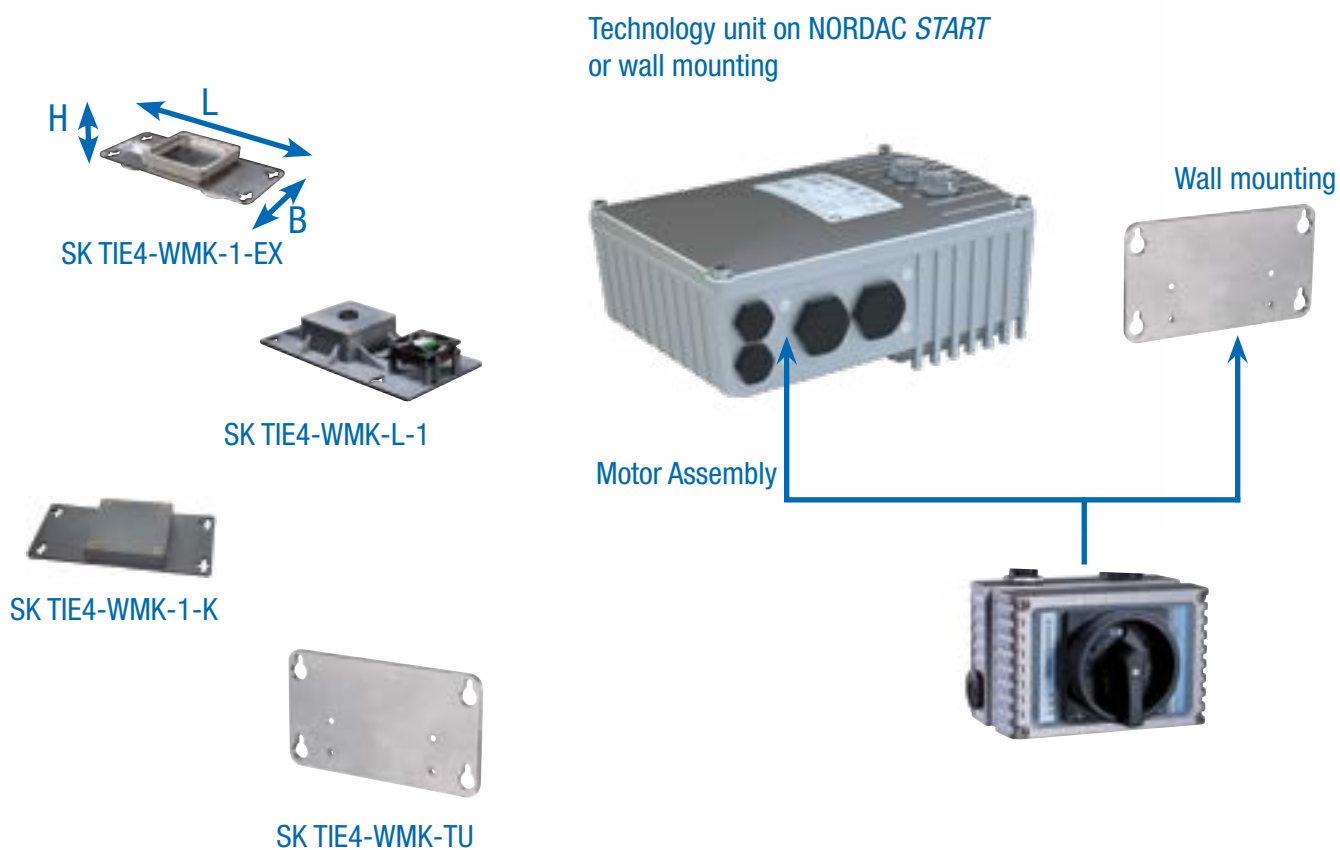

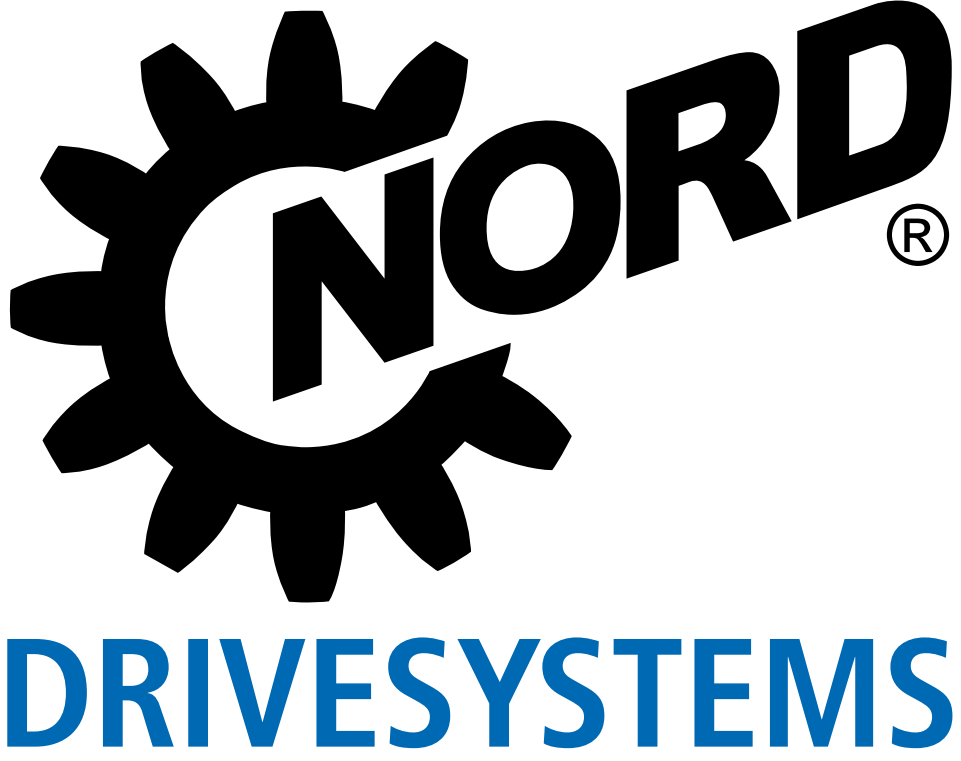



Accessories for frequency
inverters and motor starters



Accessories

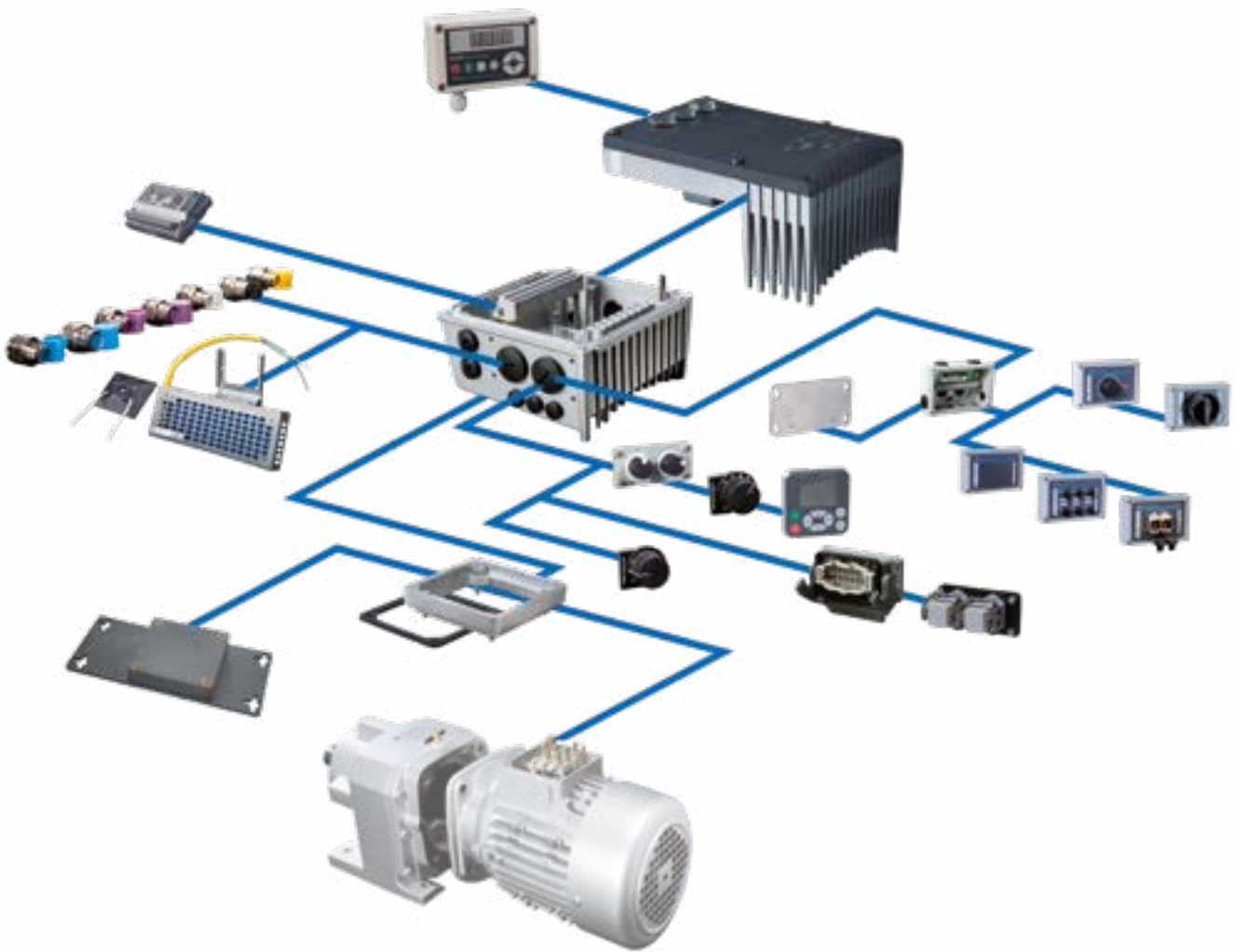

Please find a full range of accessories below that can be equally used for different series. This primarily applies to our decentralised devices of the *NORDAC LINK*, *NORDAC ON*, *NORDAC FLEX*, *NORDAC BASE* and *NORDAC START* series.

Operation
and parameterisation

Seite 168



Interfaces
for communication

Page 170



24 V power supply units,
potentiometers, switches, signal converters
and more

Page 176



System connectors
for power and control connections

Page 180





Connection technology
Cables

Page 184



Communication interfaces

Field bus extensions



Variant	Designation Material No.	Installation Attached / separate	Protection class	Number of inputs / outputs	Description	Remarks	NORDAC LINK	FLEX	BASE
	SK CU4-PBR 275 271 000	● ○	IP20	2 digital inputs	Interface as gateway for direct connection of up to four devices to a PROFIBUS DP® field bus. Digital signals can alternatively be connected via the front M12 round plug connector (only M12 modules)	Baud rate: maximum 12 MBd Protocol: DPV 0 and DPV 1 SK TU4 modules plus matching SK T14-TU-BUS / SK T14-TU-BUS-C connection unit	●	●	●
	SK CU4-PBR-C¹ 275 271 500	● ○	IP20	2 digital inputs			●	●	●
	SK TU4-PBR 275 281 100	○ ●	IP55	4 digital inputs			○	○	○
	SK TU4-PBR-C 275 281 150	○ ●	IP66	4 digital inputs			○	○	○
	SK TU4-PBR-M12 275 281 200	○ ●	IP55	2 digital outputs			○	○	○
	SK TU4-PBR-M12-C 275 281 250	○ ●	IP66	2 digital outputs			○	○	○
	SK CU4-CAO 275 271 001	● ○	IP20	2 digital inputs	Interface as gateway for direct connection of up to four devices to a CANopen® field bus. Digital signals can alternatively be connected via the front M12 round plug connector (only M12 modules)	Baud rate: maximum 1 MBaud Protocol: DS 301 and DS 402 SK TU4 modules plus matching SK T14-TU-BUS / SK T14-TU-BUS-C connection unit	●	●	●
	SK CU4-CAO-C¹ 275 271 501	● ○	IP20	2 digital inputs			●	●	●
	SK TU4-CAO 275 281 101	○ ●	IP55	4 digital inputs			○	○	○
	SK TU4-CAO-C 275 281 151	○ ●	IP66	4 digital inputs			○	○	○
	SK TU4-CAO-M12 275 281 201	○ ●	IP55	2 digital outputs			○	○	○
	SK TU4-CAO-M12-C 275 281 251	○ ●	IP66	2 digital outputs			○	○	○

¹ Version with varnished circuit boards for applications in IP6X devices

- Available as standard
- Not available

Communication interfaces















Field bus extensions

Variant	Designation Material No.	Installation	Attached / separate Protection class	Number of inputs / outputs	Description	Remarks	LINK	FLEX	NORDAC BASE
  DeviceNet®	SK CU4-DEV 275 271 002	●	○	IP20	2 digital inputs		●	●	●
	SK CU4-DEV-C ¹ 275 271 502	●	○	IP20		Interface as gateway for direct connection of up to four devices to a DeviceNet® field bus. Digital signals can alternatively be connected via the front M12 round plug connector (only M12 modules)	○	●	●
	SK TU4-DEV 275 281 102	○	●	IP55		Baud rate: maximum 500 kBaud	○	●	●
	SK TU4-DEV-C 275 281 152	○	●	IP66	4 digital inputs	Profile: AC-Drive and NORD-AC	○	●	●
	SK TU4-DEV-M12 275 281 202	○	●	IP55	2 digital outputs	SK TU4 modules plus matching SK T14-TU-BUS / SK T14-TU-BUS-C connection unit	○	●	●
	SK TU4-DEV-M12-C 275 281 252	○	●	IP66			○	●	●

¹ Version with varnished circuit boards for applications in IP6X devices

- Available as standard
- Not available

Communication interfaces Industrial Ethernet extensions

Variant	Designation Material No.	Installation	Attached / separate	Protection class	Number of inputs / out- puts	Description	Remarks	NORDAC LINK	NORDAC FLEX	NORDAC BASE
Industrial Ethernet	 SK CU4-ETH 275271027	●	○	IP20	2 digital inputs	Interface as gateway for direct connection of up to four devices to the Industrial Ethernet. Parameterisation may be used with a choice between the following dialects: EtherCAT, EtherNet/IP, PROFINET IO		●	●	●
	 SK CU4-ETH-C 275271527	●	○	IP20				●	●	●
	 SK TU4-ETH 275281132	○	●	IP55	8 digital inputs		Baud rate: max. 100 Mbaud, EtherCAT: CoE, PROFINET IO: Conformance class B and C	○	●	●
	 SK TU4-ETH-C 275281182	○	●	IP66	2 digital outputs	Connection of the bus cable via the front RJ45 or M12 circular connectors (only TU4 modules).		○	●	●
	 SK TU4-ETH-M12 275281233	○	●	IP55				○	●	●
	 SK TU4-ETH-M12-C 275281283	○	●	IP66				○	●	●
PROFIsafe	 SK TU4-PNS 275281116	○	●	IP55		Interface as gateway for direct connection of up to four devices to a PROFIsafe field bus.	Baud rate: maximum 100 Mbaud, Conformance class B and C,	○	●	○
	 SK TU4-PNS-C 275281166	○	●	IP66	2 safe digital inputs(SI), 3 safe digital outputs(SO)	Connection of the bus cable via the front RJ45 or M12 round plug connector. (only TU4 modules)		○	●	○
	 SK TU4-PNS-M12 275281216	○	●	IP55			SK TU4 modules plus matching SK TI4-TU4-SAFE / SK TI4-TU4-SAFE-C connection unit	○	●	○
	 SK TU4-PNS-M12-C 275281266	○	●	IP66				○	●	○
POWERLINK	 SK CU4-POL 275271018	●	○	IP20	2 digital inputs	Interface as gateway for direct connection of up to four devices to a POWERLINK field bus.	Baud rate: maximum 100 Mbaud, SK CU4 module: Derating (see data sheet)	●	●	●
	 SK CU4-POL-C' 275271518	●	○	IP20				●	●	●
	 SK TU4-POL 275281118	○	●	IP55	8 digital inputs	Connection of the bus cable via the front M12 round plug connector (only TU4 modules)	SK TU4 modules plus matching SK TI4-TU4-BUS / SK TI4-TU4-BUS-C connection unit	○	●	●
	 SK TU4-POL-C 275281168	○	●	IP66	2 digital outputs			○	●	●

¹ Version with varnished circuit boards for applications in IP6X devices

- Available as standard
- Not available

Communication interfaces and connection units

Variant	Designation Material No.	Installation Attached / separate	Protection Class	Number of inputs / outputs	Description	Remarks	NORDAC LINK FLEX BASE
 IO extensions	SK CU4-IOE2 275 271 007	● ○	IP20	2 ² digital and 2 ³ analogue inputs,		Analogue signals: IN / OUT: 0(2) ... +10 V or 0(4) ... 20 mA	● ● ●
	SK CU4-IOE2-C ¹ 275 271 507	● ○	IP20	2 analogue outputs			● ● ●
	SK CU4-IOE 275 271 006	● ○	IP20	2 digital and 2 ³ analogue inputs,	Sensor and actuator signal processing, connection via terminal bar Alternative connection of digital signals via front M12 round plug connector (only M12 modules)	Analogue signals: IN: -10 V ... +10 V or 0(4) ... 20 mA OUT: 0(2) ... +10 V or 0(4) ... 20 mA	● ● ●
	SK CU4-IOE-C ¹ 275 271 506	● ○	IP20	1 analogue output			● ● ●
	SK TU4-IOE 275 281 106	○ ●	IP55	4 digital and 2 analogue inputs,		SK TU4 modules plus matching SK T14-TU-BUS / SK T14-TU-BUS-C connection unit	○ ● ●
	SK TU4-IOE-C 275 281 156	○ ●	IP66	2 digital and 1 analogue output			○ ● ●
	SK TU4-IOE-M12 275 281 206	○ ●	IP55				○ ● ●
	SK TU4-IOE-M12-C 275 281 256	○ ●	IP66				○ ● ●



¹ Version with varnished circuit boards for applications in IP6X devices

² Digital inputs can optionally be used as digital inputs or outputs

³ Analogue inputs can optionally be used as analogue or digital inputs

- Available as standard
- Not available

NORDAC
LINK
FLEX
BASE

Variant	Designation Material No.	Installation / Attached / separate Protection class	Description
	SK T14-TU-BUS 275 280 000	<input type="radio"/> IP55	Connection unit for SK TU4-... bus interfaces or IO - extensions (IP55), including RS-232 diagnostic interface (RJ12 port)
	SK T14-TU-BUS-C 275 280 500	<input type="radio"/> IP66	Connection unit for SK TU4-... bus interfaces or IO - extensions (IP66), including RS-232 diagnostic interface (RJ12 port)
	SK T14-TU-SAFE 275 280 300	<input type="radio"/> IP55	Connection unit for safe bus interface SK TU4-PNS-... (IP55), including RS-232 diagnostic interface (RJ12 port)
	SK T14-TU-SAFE-C 275 280 800	<input type="radio"/> IP66	Connection unit for safe bus interface SK TU4-PNS-...-C (IP66), including RS-232 diagnostic interface (RJ12 port)
	SK TIE4-WMK-TU 275 274 002	<input type="radio"/> IP66	For separate mounting of SK TU4... modules with SK T14-TU-...

Connection units

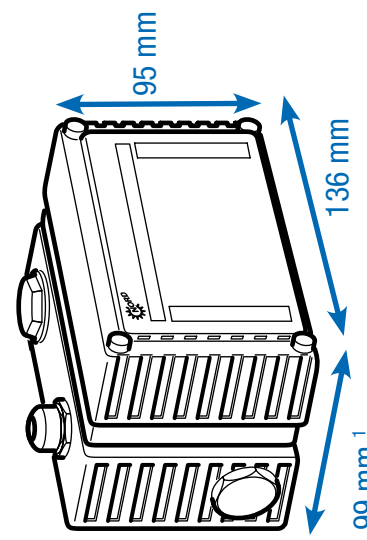

- Available as standard
- Not available



¹ Depth varies for versions with connections on the front side.

Supply and control



24 V power supply units, potentiometer and switches

Variant	Designation Material No.	Installation Attached / separate	Protection class	Description	Remarks	FLEX	BASE	NORDAC START
	SK CU4-24V-123-B 275 271 108	●	○ IP20	Output: 24 V DC, 420 mA	For connection to 115 V/230 V devices, including AD converter for evaluation of a 10 kΩ - potentiometer	●	●	
	SK CU4-24V-123-B-C ¹ 275 271 608	●	○ IP20	Output: 24 V DC, 420 mA		●	●	
	SK CU4-24V-140-B 275 271 109	●	○ IP20	Output: 24 V DC, 420 mA	For connection to 400 V/500 V devices, including AD converter for evaluation of a 10 kΩ - potentiometer	●	●	
	SK CU4-24V-140-B-C ¹ 275 271 609	●	○ IP20	Output: 24 V DC, 420 mA		●	●	
	SK TU4-24V-123-B 275 281 108	○	● IP55	Output: 24 V DC, 420 mA	For connection to 115 V/230 V devices, including AD converter for evaluation of a 10 kΩ - potentiometer	●	●	
	SK TU4-24V-123-B-C 275 281 158	○	● IP66	Output: 24 V DC, 420 mA		plus suitable connection unit SK T14-TU-NET/SK T14-TU-NET-C	●	●
	SK TU4-24V-140-B 275 281 109	○	● IP55	Output: 24 V DC, 420 mA	For connection to 400 V/500 V devices, including AD converter for evaluation of a 10 kΩ potentiometer plus suitable connection unit SK T14-TU-NET/SK T14-TU-NET-C	●	●	
	SK TU4-24V-140-B- 275 281 159	○	● IP66	Output: 24 V DC, 420 mA		●	●	

Power supplies









¹ Version with varnished circuit boards for applications in IP6X devices

- Available as standard
- Not available

Variant	Designation Material No.	Installation	Attached / separate Protection Class	Description	Remarks	FLEX	BASE	NORDAC START
Power supplies with control unit	 SK TU4-POT-123-B 275 281 110	<input type="radio"/>	<input checked="" type="radio"/> IP55	Output: 24 V DC, 420 mA	For connection to 115 V / 230 V devices, including setpoint adjuster 0% ... 100% and keys "ON R" - "OFF" - "ON L" plus suitable SK T14-TU-NET/SK T14-TU-NET-C connection unit	<input checked="" type="radio"/>	<input checked="" type="radio"/>	<input checked="" type="radio"/>
		<input type="radio"/>	<input checked="" type="radio"/> IP66	Output: 24 V DC, 420 mA		<input checked="" type="radio"/>	<input checked="" type="radio"/>	<input checked="" type="radio"/>
	SK TU4-POT-140-B 275 281 111	<input type="radio"/>	<input checked="" type="radio"/> IP55	Output: 24 V DC, 420 mA	For connection to 400 V / 500 V devices, including setpoint adjuster 0% ... 100% and keys "ON R" - "OFF" - "ON L" plus suitable SK T14-TU-NET/SK T14-TU-NET-C connection unit	<input checked="" type="radio"/>	<input checked="" type="radio"/>	<input checked="" type="radio"/>
		<input type="radio"/>	<input checked="" type="radio"/> IP66	Output: 24 V DC, 420 mA		<input checked="" type="radio"/>	<input checked="" type="radio"/>	<input checked="" type="radio"/>
Connection units	 SK T14-TU-NET 275 280 100	<input type="radio"/>	<input checked="" type="radio"/> IP55	SK T14-... connection unit for power supply units (IP55)	<input checked="" type="radio"/>	<input checked="" type="radio"/>	<input checked="" type="radio"/>	<input checked="" type="radio"/>
		<input type="radio"/>	<input checked="" type="radio"/> IP66	SK T14-... connection unit for power supply units (IP66)	<input checked="" type="radio"/>	<input checked="" type="radio"/>	<input checked="" type="radio"/>	<input checked="" type="radio"/>
	 SK TIE4-WMK-TU 275 274 002	<input type="radio"/>	<input type="radio"/> IP66	For separate mounting of SK TU4... modules with SK T14-TU-...	<input checked="" type="radio"/>	<input checked="" type="radio"/>	<input checked="" type="radio"/>	<input checked="" type="radio"/>





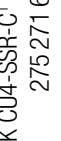
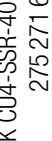

- Available as standard
- Not available

Supply and control Signal converters and more

Variant	Designation Material No.	Installation Attached / separate Protection Class	Description	Remarks	FLEX	BASE	NORDAC START
Control elements	 SK CU4-POT 275 271 207	○ IP66	Switches and potentiometers	Switches: "ON R" - "OFF" - "ON L", 10 - kΩ potentiometer	●	●	○
	 SK TIE4-SWT 275 274 701	○ IP66	Switch	"ON R" - "OFF" - "ON L"	●	●	●
	 SK TIE4-POT 275 274 700	○ IP66	Potentiometer	10 kΩ potentiometer	●	●	○
	 SK ATX-POT 275 142 000	○ IP66	Potentiometer	10 kΩ - potentiometer, approved for use in ATEX Zone 22 3D	●	●	○
	 SK CU4-REL 275 271 011	● IP20	2x AIN / AOJT, 2 DIN / relay	Converter for analogue signals -10 ... +10 V to 0 ... 10 V, 2 x changeover relay outputs 1 A (≤ 30 V), controlled via a digital input	●	●	○
	 SK CU4-REL-C' 275 271 511	○ IP20			●	●	○
Signal converter and relay	 SK CU4-REL-POW 275 271 012	● IP20	2x AIN / AOJT, 2 DIN / relay	Converter for analogue signals -10 ... +10 V to 0 ... 10 V, 2 x changeover relay outputs 8 A (≤ 30 V), controlled via a digital input	●	●	○
	 SK CU4-MBR 275 271 010	● IP20	230 V / 400 V, max. 0.5 A	For direct control and supply of an electromagnetic holding brake	●	●	○
	 SK CU4-MBR-C' 275 271 510	○ IP20			●	●	○
	 SK CU4-SSR 275 271 124	● IP20	2x DIN / relay	Relay outputs (NO), suitable for AC / DC (max. 277 V AC, 850 mA / 24 V DC +/- 25%, 850 mA), control either synchronously via a digital input or individually via one digital input each	●	●	○
	 SK CU4-SSR-C' 275 271 624	○ IP20			●	●	○
	 SK CU4-SSR -400 275 271 128	● IP20	2x DIN / relay	Relay outputs (NO), suitable for AC (480 V AC +10%, max. 300 mA), control either synchronously via a digital input or individually via one digital input each	●	●	○
	 SK CU4-SSR-400-C' 275 271 628	○ IP20			●	●	○

¹ Version with varnished circuit boards for applications in IP6X devices

- Available as standard
- Not available

Variant	Designation Material No.	Installation Attached / separate Protection class	Description	Remarks	NORDAC START	NORDAC BASE	NORDAC FLEX
Residual voltage discharge	 SK CU4-PD1 275271 025	● ○ IP20	Module for residual voltage dissipation	Load resistance 3 x 470 kOhm, ≤ 550 V AC/DC, ≤ 20 A	● ○	● ○	● ○
	SK CU4-PD1-C' 275271 525	● ○ IP20			● ○	● ○	● ○
Residual voltage discharge	 SK CU4-PD2 275271 026	● ○ IP20	Module for residual voltage dissipation	Load resistance 3 x 160 kOhm, ≤ 550 V AC/DC, ≤ 20 A	● ○	● ○	● ○
	SK CU4-PD2-C' 275271 526	● ○ IP20			● ○	● ○	● ○
Switch	 SK TU4-MSW 275281 123	○ ● IP55	1 ~ 100 - 240 V / 3 ~ 200 - 500 V, 16 A	Switch to disconnect the device from the power supply, black twist grip plus suitable SK T14-TU-MSW/SK T14-TU-MSW-C connection unit	● ●	● ●	● ●
	SK TU4-MSW-C 275281 173	○ ● IP66	1 ~ 100 - 240 V / 3 ~ 200 - 500 V, 16 A		● ●	● ●	● ●
Connection units	 SK T14-TU-MSW 275280 200	○ ● IP55		SK TU4-... connection unit for maintenance switches (IP55)	● ●	● ●	● ●
	 SK T14-TU-MSW-C 275280 700	○ ● IP66		SK TU4-... connection unit for maintenance switches (IP66)	● ●	● ●	● ●
Connection units	 SK TIE4-WMK-TU 275274 002	○ ○ IP66		For separate mounting of SK TU4... modules with SK T14-TU-...	● ●	● ●	● ●

¹ Version with varnished circuit boards for applications in IP6X devices

- Available as standard
- Not available

Perfect connections with system plug connectors

The use of optionally available plug connectors for power and control connections not only makes it possible to replace the drive unit with almost no loss of time in case of servicing, but also minimises the danger of installation errors when connecting the device. This enables the perfect construction of an energy or communication bus. Typical plug connector versions are summarised below.



Plug connectors for power connections

Plug connectors from various manufacturers are available for the motor or mains connection for rated currents of up to 20A.

Type	Data	Designation	Material No.	NORDAC		
				FLEX	BASE	START
Input (power and control voltage)	400 V, 16 A + 24 V, 4 A	SK TIE4-HANQ4-M-LE-MX	275 274 113	●	●	●
Input (power and control voltage)	400 V, 16 A + 24 V, 10 A	SK TIE4-NQ16-K-LE	275 274 133	●	●	○
Input and output (power and control voltage)	400 V, 32 A + 24 V, 4 A	SK TIE4-2HANQ4-M-LE-LA	275 274 112	●	●	●
Input and output (power and control voltage)	400 V, 40 A + 24 V, 6 A	SK TIE4-2HANQ4-M-LE-LA-6mm	275 274 119	●	●	●
Power input	500 V, 16 A	SK TIE4-HAN10E-M1B-LE	275 135 070	●	●	●
Power input	500 V, 16 A	SK TIE4-HAN10E-M2B-LE	275 135 000	●	●	●
Power input	500 V, 16 A	SK TIE4-HANQ8-M-LE-MX	275 135 030	●	●	●
Power input	690 V, 20 A	SK TIE4-QPD4SPM	275 274 185	●	●	●
Power output	500 V, 16 A	SK TIE4-HAN10E-M2B-LA	275 135 010	●	●	●
Power output	500 V, 16 A	SK TIE4-HANQ8-M-LA-MX	275 135 040	●	●	●
Motor output	500 V, 16 A	SK TIE4-HAN10E-M2B-MA	275 135 020	●	●	●
Motor output	500 V, 16 A	SK TIE4-HANQ8-M-MA-MX	275 135 050	●	●	●
Power input + motor or power output	400 V, 16 A	SK TIE4-2HANQ5-K-LE-LA	275 274 110	●	●	●

● Available as standard
○ Not available



Plug connectors for control connections

Various M12 round plug connectors are available as flanged plugs or flanged sockets. The plug connectors are intended for installation in an M16 screw fitting on the device and can be oriented in any direction. The protection class (IP67) of the plug connector only applies in the screwed state. The cover caps correspond to the colour version as does the plastic body of the plug connector. Expansion and reducer adapters are available for installation in an M12 or M20 screw fitting.



Type	Version	Designation	Material No.	NORDAC		
				FLEX	BASE	START
System bus IN	Plug connectors	SK TIE4-M12-SYSS	275 274 506	●	●	○
System bus OUT	Bushing	SK TIE4-M12-SYSM	275 274 505	●	●	○
Power supply	Plug connectors	SK TIE4-M12-POW	275 274 507	●	●	●
Sensors/actuators	Bushing	SK TIE4-M12-INI	275 274 503	●	●	●
Sensors/actuators	Plug connectors	SK TIE4-M12-INP	275 274 516	●	●	●
Analogue signal	Bushing	SK TIE4-M12-ANA	275 274 508	●	●	○
HTL encoder	Bushing	SK TIE4-M12-HTL	275 274 512	●	○	○
Safe stop	Plug connectors	SK TIE4-M12-SH-IN	275 274 519	●	○	○
Safe stop	Bushing	SK TIE4-M12-SH	275 274 509	●	○	○
AS-Interface	Plug connectors	SK TIE4-M12-ASI	275 274 502	●	●	●
AS-Interface – Aux	Plug connectors	SK TIE4-M12-ASI-AUX	275 274 513	●	●	●
CANopen® / DeviceNet® IN	Plug connectors	SK TIE4-M12-CAO	275 274 501	●	●	○
CANopen® / DeviceNet® OUT	Bushing	SK TIE4-M12-CAO-OUT	275 274 515	●	●	○
Ethernet	Bushing	SK TIE4-M12-ETH	275 274 514	●	●	○
PROFIBUS® (IN + OUT)	Connector + socket	SK TIE4-M12-PBR	275 274 500	●	●	●
Connection extension	M12 - M16	SK TIE4-M12-M16	275 274 510	●	●	●
Connection reduction	M20 – M16	SK TIE4-M20-M16	275 274 511	●	●	●

● Available as standard
○ Not available



Installation locations for system connectors

System connectors

The devices provide various screw fittings which can be used for the installation of cable glands or system connectors. Screw-in reduction or expansion adapters enable the connection of additional cable cross sections as required.

NORDAC FLEX (SK TI4-...)

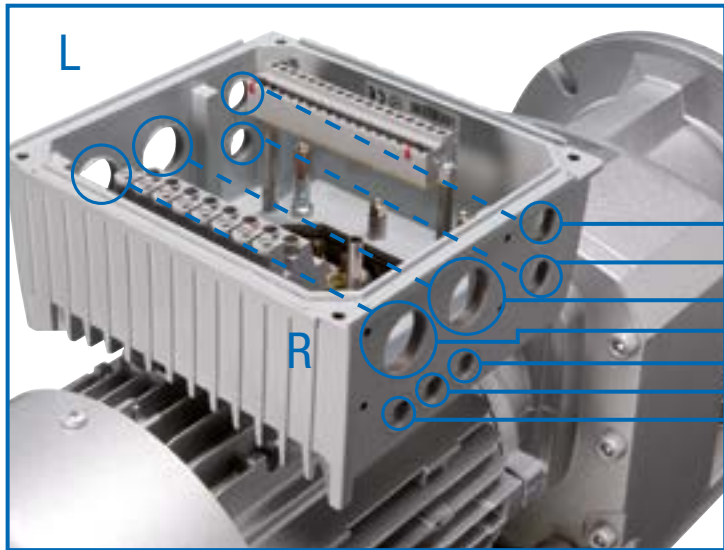

NORDAC BASE and NORDAC START

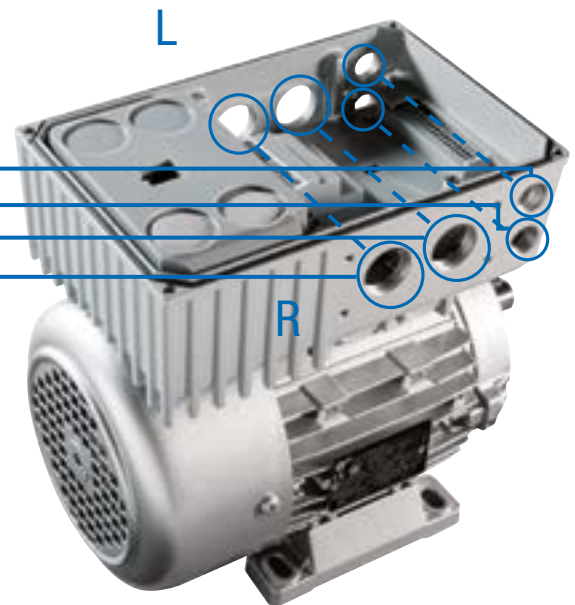

Option locations (R or L assignment, view towards the motor fan)

- | | | | |
|---|-----|-----|--|
| 3 | L/R | 2 x | M25 screw fitting (A/B) |
| 4 | L/R | | M16 screw fitting |
| 5 | L/R | | M16 screw fitting |
| 6 | L/R | | M12 screw fitting, BG 4 → M16 (only NORDAC FLEX) |
| 7 | L/R | | M12 screw fitting, BG 4 → M16 (only NORDAC FLEX) |
| 8 | L/R | | M12 screw fitting, BG 4 → M16 (only NORDAC FLEX) |

Size 4 Additional screw fitting L/R: M32
(only NORDAC FLEX)

The plug connectors for the power connection are installed at position 3 (R or L).

Connection unit - Technology Unit

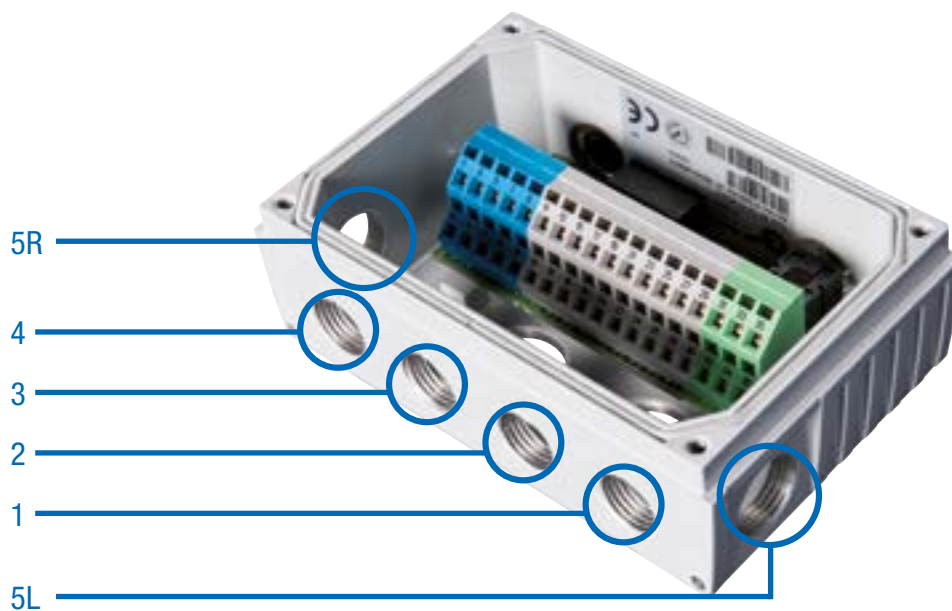

Optionsplätze der SK TI4-TU-...

- 1 M16 screw fitting
- 2 M16 screw fitting
- 3 M16 screw fitting
- 4 M16 screw fitting
- 5 L/R M20 screw fitting



Not to be underestimated – the correct connection method

With the NORDAC *LINK*, *FLEX*, *BASE* and *START* frequency inverters and motor starters, the NORD DRIVESYSTEMS Group provides the right product for motor control for all decentralised drive technology applications. The advantages, such as short motor cables, improved EMC and installation without control cabinets are obvious.

Connection of the decentralised components (motor and electronics) is made either with a permanent connection with cable glands¹ or can be in the form of plug connectors. However, the full advantages of decentralised drive technology are only achieved with the selection of plug-in connectors.

- ▶ Quick and simple electrical connection
- ▶ Minimisation of connection errors
- ▶ Minimum installation effort for installation, maintenance and servicing
- ▶ Reduced downtime in case of replacement

NORD supplies an extensive range of connection and control cables.

- ▶ Depending on the version, connecting cables include power connection cables (mains and motor) and if necessary cables for thermistors as well as 24 V DC control voltage.
- ▶ Control cables are exclusively used for transmitting control signals (encoder, bus, IO signals).

Connection and control cables are supplied pre-assembled. They are available in various lengths and can optionally be provided with open ends or plug connectors. Typically, all cables² are shielded.

¹ Not for NORDAC *LINK*, NORDAC *ON*

² Except for mains connection/daisy chain cables



Designation of pre-assembled cables

Pre-assembled cables

- ▶ Cables for motor and frequency inverter connection
- ▶ Mains connection and signal cables
- ▶ Customised plug connectors and cable lengths

SC H4G2.5 HQ8SMM H10E1SMF 1.5 UL

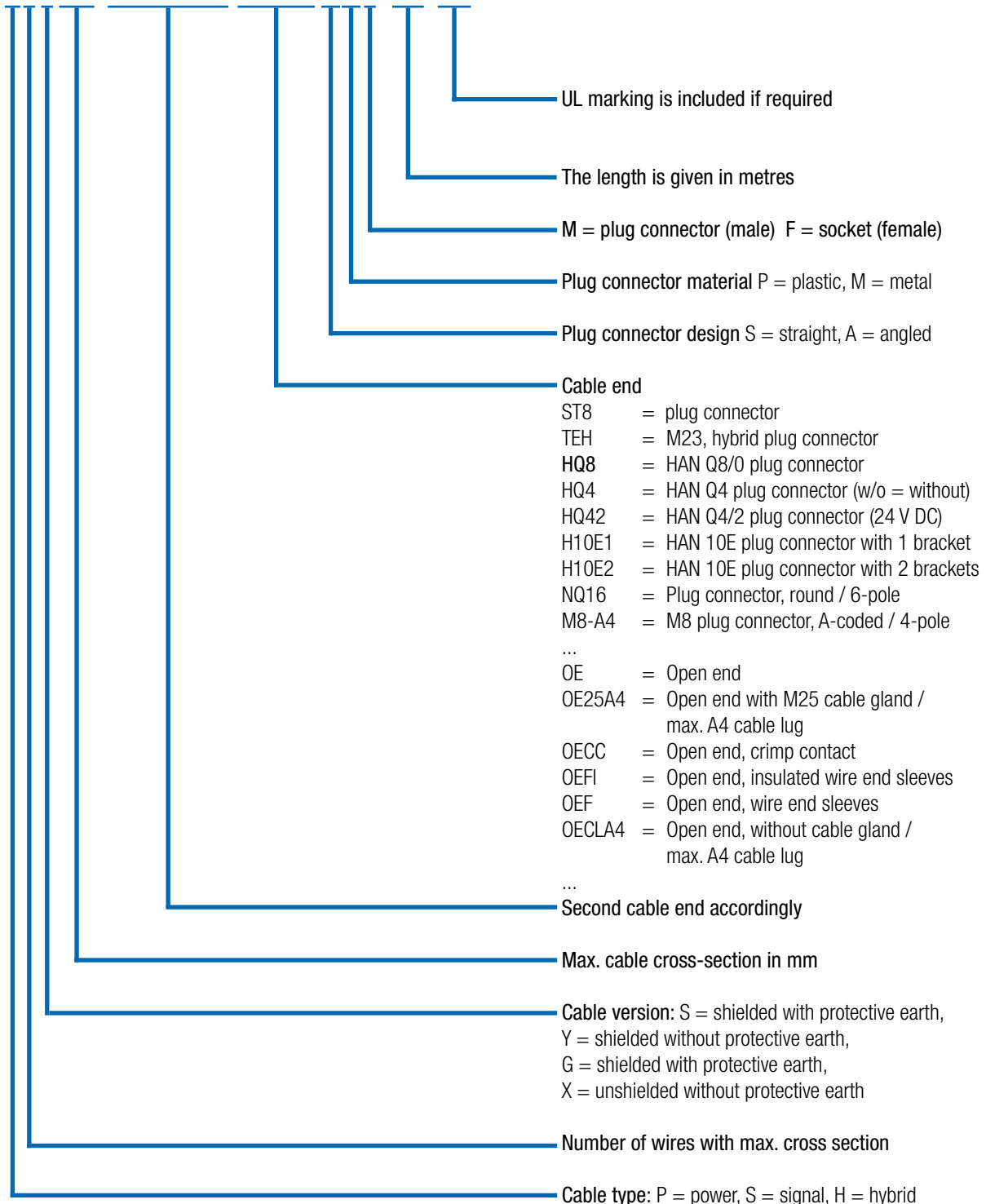

Technical data

cables

The design depends on the ambient conditions and the type of installation and must be decided by the customer. All options can be requested from NORD according to the specific project.

Feature	Standard	Options
Conductor material	Copper	-
Installation type	Permanent installation	-
Cable insulation	Polyvinyl chloride (PVC)	Polyurethane (PUR)
Protective sleeve	No	On request
Cable length	Motor cables: 1.5 m – 3.0 m – 5.0 m Mains cables: 1.5 m – 3.0 m – 5.0 m Daisy chain cables: 1.5 m – 3.0 m – 5.0 m Encoder cables: 1.5 m – 3.0 m – 5.0 m Brake resistor cables: 2.0 m – 3.0 m	On request

Motor cables

Product overview – Motor cables

Depending on the motor, the following shielded motor connection cables are available.





NORDAC LINK, FLEX, BASE, START

Designation	Motor power [kW]	Certification	Part number for length [m]		
			1.5	3	5
SC H4S2.5 HQ8SPM OE20A4 UL	0,12 - 0,37	EU / UL	275 274 800	275 274 801	275 274 802
SC H4S2.5 HQ8SPM OE25A4 UL	0,55 - 1,5	EU / UL	275 274 805	275 274 806	275 274 807
SC H4S2.5 HQ8SPM OE32A4 UL	2,2 - 3,0	EU / UL	275 274 825	275 274 826	275 274 827
SC H4S2.5 HQ8SPM OE32A5 UL	4,0	EU / UL	275 274 830	275 274 831	275 274 832
SC H4S4 HQ8SPM OE32A6 UL	5,5 - 9,2	EU / UL	275 274 835	275 274 836	275 274 837
SC H4S2.5 HQ8SPM H10E1SMF	0,12 - 4,0	EU	275 274 810	275 274 811	275 274 812

NORDAC ON

Designation	Motor power [kW]	Certification	Part number for length [m]		
			1.5	3	5
SC H4S1 ST8SMM OE20A4 UL	63 – 71 IE1 - IE3	EU / UL	275 274 690	275 274 691	275 274 692
SC H4S1 ST8SMM OE20A4 UL WOB ¹	63 – 71 IE1 - IE3	EU / UL	275 274 617	275 274 618	275 274 619
SC H4S1 ST8SMM OE25A4 UL	80 – 90 IE1 - IE3 71 IE5+	EU / UL	275 274 695	275 274 696	275 274 697
SC H4S1 ST8SMM OE25A4 UL WOB ¹	80 – 90 IE1 - IE3 71 IE5+	EU / UL	275 274 621	275 274 622	275 274 623
SC H4S1 ST8SMM HQ8SMF UL	NORD Motorstecker „MS21“	EU / UL	275 274 685	275 274 686	275 274 687
SC H4S1.5 TEH51SVM TEH51SVF MBE ²		EU / UL	in preparation	in preparation	in preparation

Frequency inverter/Motor starter connection

	Motor connection	Required motor option ¹
	 Open ends	ZKK
		MS31 or MS31E

¹For further information about motor options please refer to motor catalogue M7000

Mains cables / Daisy chain cables

Product overview – Mains cable

The following unshielded mains cables are available. A simple plug-in connection for frequency inverters can be achieved with the HQ4 variant. With a further variant (HQ42) a 24 V DC supply can also be implemented.

Designation	24 V DC supply	Certification	Part number for length [m]		
			1.5	3	5
SC P4G2.5 HQ4SPF OE	no	EU	275 274 840	275 274 841	275 274 842
SC P4GA14 HQ4SPF OE UL	no	UL		275 274 241	275 274 242
SC H4G4 HQ42SPF OE	yes	EU	275 274 845	275 274 846	275 274 847
SC H4GA12 HQ42SPF OE UL	yes	UL		275 274 246	275 274 247
SC H6G2.5 NQ16SPF OE UL ¹	yes	UL	275 274 218	275 274 219	275 274 220

¹ only NORDAC *ON*



A daisy chain cable is designed for looping the mains connection (plug connections on both sides) from one frequency inverter to the next. The variants as for mains cables are available. These cables are also unshielded.

Designation	24 V DC supply	Certification	Part number for length [m]		
			1.5	3	5
SC P4G4 HQ4SPM HQ4SPF	no	EU	275 274 850	275 274 851	275 274 852
SC P4GA12 HQ4SPM HQ4SPF UL	no	UL		275 274 251	275 274 252
SC H4G4 HQ42SPM HQ42SPF	yes	EU	275 274 855	275 274 856	275 274 857
SC H4GA12 HQ42SPM HQ42SPF UL	yes	UL		275 274 256	275 274 257
SC H6G2.5 NQ16SPM NQ16SPF UL ¹	yes	UL	275 274 288	275 274 289	275 274 290

¹ only NORDAC *ON*



Brake resistor cable / Control cables

Product overview – Braking resistor cables

The following shielded cables are available for connecting an external brake resistor

Designation	Certification	Part number for length [m]	
		2	3
SC P3S2.5 HQ2SPM OE	EU	275 274 881	275 274 899
SC P3SA14 HQ2SPM OE UL	UL	275 274 280	275 274 281



Product overview – Control cables

Control cables for connection to an encoder are typically connected with so-called “M12 plug connectors”. The following system solutions are available for encoder connection.

Designation	Motors			Encoders ¹	Cable type	Control cable Length - Part No.
	IE1-3	IE4	IE5+			
SC S4Y0.25 M12-B4MM M12-A8SMF	●	○	○	IG12P - 19 651 501	HTL without zero track	1.5 m - 275 274 675
				IG22P - 19 651 511		3.0 m - 275 274 676
				IG42P - 19 651 521		5.0 m - 275 274 677
SC S5S0.25 M12-A5SPM M12-A5SPF	○	●	○	IG22P5 - 19 651 910	HTL with zero track	1.5 m - 275 274 874
	○	○	●	IG62P5 - 19 605 002		3.0 m - 275 274 876
						5.0 m - 275 274 877
SC S5Y0.25 M12-A5SMM M12-A8SMF	○	●	○	IG22P8 - 19 651 911	HTL with zero track	1.5 m - 275 274 645
						3.0 m - 275 274 646
						5.0 m - 275 274 647

- Available as standard
- Not available

¹ Further information about encoders can be obtained from motor catalogue M7000.

Headquarters:

Getriebebau NORD GmbH & Co. KG

Getriebebau-Nord-Str. 1

22941 Bargteheide, Deutschland

T: +49 (0) 45 32 / 289 - 0

F: +49 (0) 45 32 / 289 - 22 53

info@nord.com